

CATALOGUE

2022

**B**

Bontà

Il gusto  
va avanti sempre

La presenza di un'ampia gamma di  
prodotti è sinonimo di qualità e  
di un'offerta completa

Per noi il cliente è sempre al centro  
e il nostro impegno è sempre

BILANCIA

SCUOPE DI

GIUGNO

Uovo:

**SOVA**

RETAIL SOLUTIONS

# True Ideas for Retail Spaces

*We realize your stores with the most suitable concept and rich equipment options for your business model. From design to cost analysis, production to installation, we manage all processes for you. From your sales areas to your warehouse, we provide solutions for all your equipment needs.*



## IN 30 COUNTRIES OF THE WORLD, WITH HIGH EXPERTISE AND KNOWLEDGE, «SOVATEAM» HAVE SIGNED MANY PROJECTS RE-SHAPING THE RETAIL & STORE DESIGN

Retailing is a dynamic process all over the world. Companies that renew themselves in this process and value the customer's comfort will always get a larger piece of the pie.

Brands who create an impressive atmosphere together with the perfect store layout, will always be one step ahead in competition.

This is where we step in. We design stores that bring more profit to retailers and make them stand out from the competition.

In order to reach this goal with the right project, equipment and at the lowest cost possible, we share all our knowledge and experience with the retail investors.



PROVIDING  
SOLUTIONS  
FOR EVERY  
KIND OF  
RETAILING,  
SOVA  
REALIZES  
YOUR  
STORE  
WITH THE  
RIGHT LAYOUT,  
BACKED UP  
BY A  
WIDE  
RANGE  
OF  
EQUIPMENT  
AND  
ACCESSORIES

■ DISCOVER OUR PRODUCT RANGE FOR  
ADDITIONAL VALUE IN YOUR BUSINESS

DYNAMIC MODULAR SYSTEM .....	<b>7</b>
FRUIT & VEGETABLE DISPLAYS .....	<b>19</b>
BAKERY DISPLAYS .....	<b>35</b>
SHELF SYSTEMS .....	<b>43</b>
LIGHT DUTY RACK SYSTEMS .....	<b>54</b>
FARMARACK DRAWER SYSTEM .....	<b>60</b>
DISPLAY EQUIPMENT .....	<b>63</b>
DISPLAY ACCESSORIES .....	<b>70</b>
HANDLING EQUIPMENT .....	<b>85</b>



# **DYNAMIC MODULAR SYSTEM**

# WHY DYNAMIC?

Dynamic is a modular display system formed by combining different types of accessories, cabinets, shelves, illuminated canopies and many other equipment in accordance with customer's requirements and current decoration if any.



Dynamic system parts are designed to feature a "snap-in" and "plug-in" structure. You don't need any bolts and nuts when installing the modules.



- MODERN
- MODULAR
- ADAPTABLE TO DIFFERENT CONCEPTS
- SUITABLE FOR MANY STORE TYPES
- VARIOUS DECORATIVE OPTIONS
- EASY INSTALLATION

**Can be used for:** Cosmetics, Glassware, Home Textile, Children's / Men's / Women's Apparel, Shoes & Bags, Underwear, Toys, Stationery, Consumer Electronics, Tobacco Shop, Supermarket and many more retail shops .



With Dynamic, you will have flexible designs for your store and change your product display as you wish. Various accessory options give you unlimited flexibility in product display.

Cabinets will help keep stock of your displayed products.

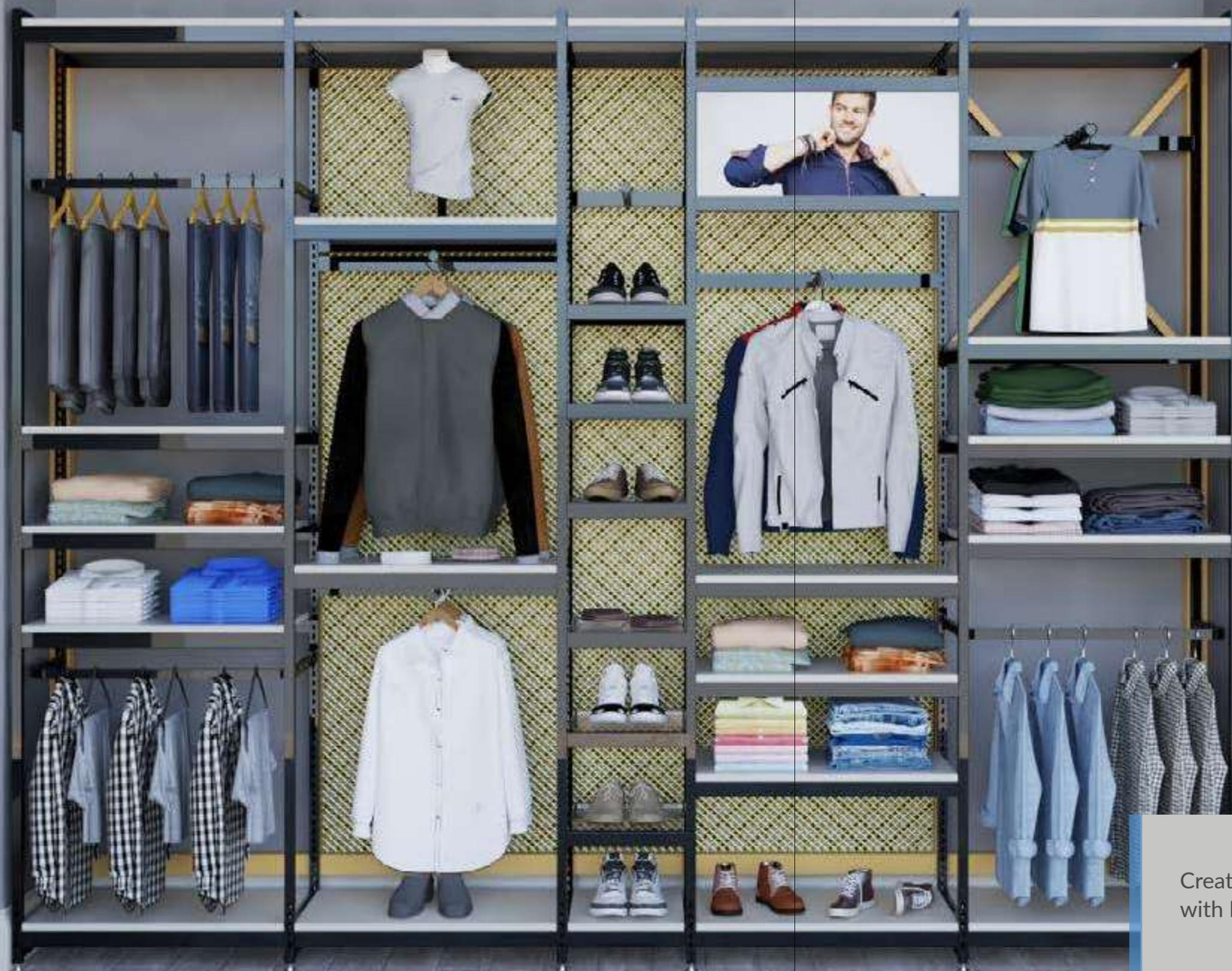

Create distinct and extraordinary design with Dynamic.



Illuminated or non-illuminated canopy designs will complete your product presentation. Thanks to the plug-in design, these canopies can be applied to different locations of the system, enriching the look of your store and making your brand stand out.



You can diversify your display and highlight your products by using the wide variety shelf types of the dynamic system. Offering various color options, Dynamic easily adapts to your store concept.





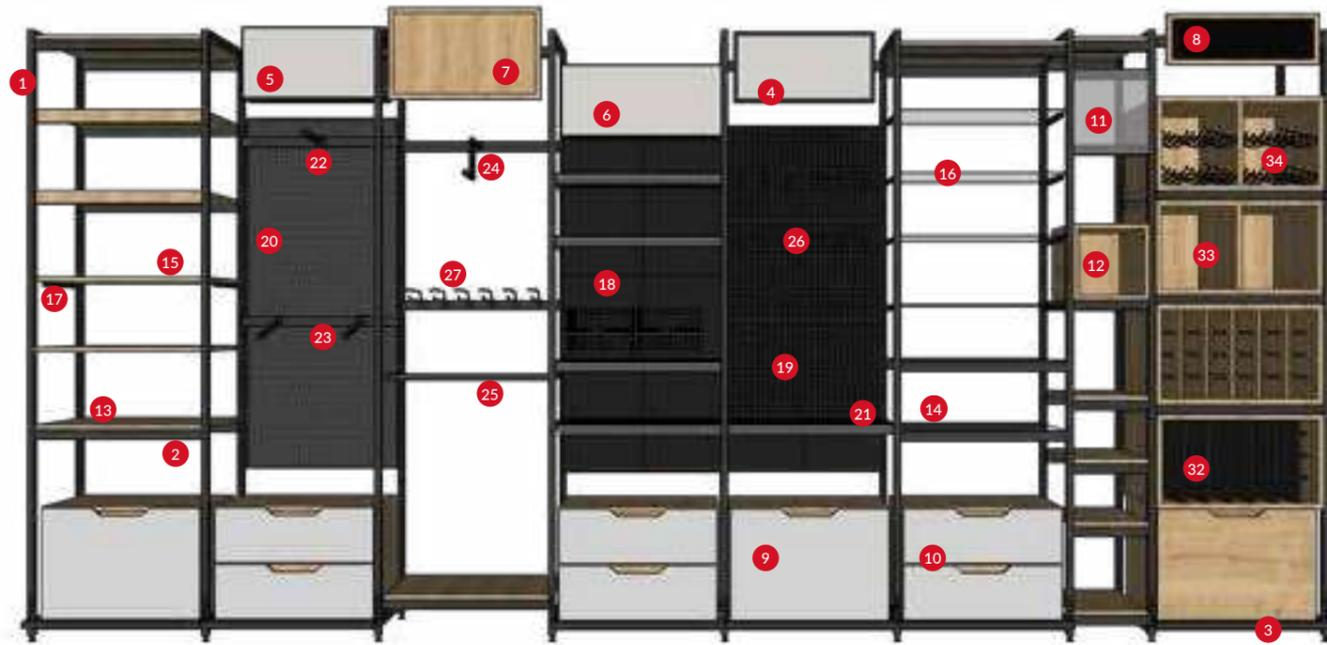

### TECHNICAL DETAILS

Metal Color Options

- RAL 7022
- SOVA BLUE
- RAL 9010

Accessory Color Options

- CHROME
- SATIN CHROME

Wood Color Options

- OAK
- CREAM
- WHITE

### POWDER COATING FEATURES

Electrostatic Epoxy Polyester Powder Coating

## DYNAMIC MODULAR SYSTEM

Part List

No	Model & Parts	Height (H)	Depth (D)	Length (L)	Illumination	Coating
1	Dynamic Frame 25x25 mm	2000 / 2500	460	-	-	Powder Coating
2	Dynamic Beam 15x25 mm	-	-	350 / 665 / 1000	-	Powder Coating
3	Dynamic Barrier 20mm	-	-	350 / 665 / 1000	-	Powder Coating
4	Dynamic Led Top Canopy 15 mm	400	15	350 / 665 / 1000	✓	Powder Coating
5	Dynamic Box Canopy With Backlight DG	400	100	350 / 665 / 1000	✓	Powder Coating
6	Dynamic Box Canopy With Backlight ATG	400	100	345 / 660 / 995	✓	Powder Coating
7	Dynamic Wooden Top Canopy	200 / 400	18	350 / 665 / 1000	-	Wooden
8	Dynamic Wooden Top Canopy With Blackboard	200 / 400	18	350 / 665 / 1000	-	Wooden
9	Wooden Single Drawer Cabinet	500	460	665 / 1000	-	Wooden
10	Wooden Double Drawer Cabinet	500	460	665 / 1000	-	Wooden
11	Plexyglass Billboard	350	-	350	-	Plexyglass
12	Dynamic Wooden Box Shelf	350	350	350	-	Wooden
13	Dynamic Wooden Shelf (Beam)	-	460	350 / 665 / 1000	-	Wooden
14	Dynamic Glass Shelf (Beam)	-	460	350 / 665 / 1000	-	Glass
15	Dynamic Wooden Shelf (Bracket)	-	400	665 / 1000	-	Powder Coating
16	Dynamic Glass Shelf (Bracket)	-	400	665 / 1000	-	Powder Coating
17	Dynamic Bracket for Wooden / Glass Self	-	400	665 / 1000	-	Powder Coating
18	Metal Back Panel	220 / 420	-	665 / 1000	-	Powder Coating
19	Metal Perforated Back Panel	420	-	665 / 1000	-	Powder Coating
20	Grille Back Panel	500 / 1000	-	665 / 1000	-	Powder Coating
21	Metal Shelf	-	400	665 / 1000	-	Powder Coating
22	Dynamic Hanger ATG	-	400	-	-	Chrome
23	Dynamic Sloping Hanger ATG	-	400	-	-	Chrome
24	Dynamic Stepped Hanger ATG	-	400	-	-	Chrome
25	Dynamic U Hanger ATG	-	400	665 / 1000	-	Chrome
26	Wire Hook DSG	-	250 / 300 / 350	-	-	Chrome
27	Wire Hook with Label Holder DSG	-	250 / 300 / 350	-	-	Chrome
28	Wire Hook Double DSG	-	250 / 300 / 350	-	-	Chrome
29	Wire Hook ATG	-	250 / 300 / 350	-	-	Chrome
30	Wire Hook with Label Holder ATG	-	250 / 300 / 350	-	-	Chrome
31	Basket Rack ATG	100	300	200	-	Powder Coating
32	Wine Rack Type 1	400	460	665 / 1000	-	Wooden
33	Wine Rack Type 2	400	460	665 / 1000	-	Wooden
34	Wine Rack Type 3	400	460	665 / 1000	-	Wooden





Wooden Covered

Authentic Pattern

Modern Pattern

● RAL 7016 ● OAK

## VEGY

Vegy brings ergonomics and richness together in fresh product display, offering flexible design, coating and size options. Wood and metal coating options make the product adaptable to your concept design. The combination of the wall and the middle section provides an integrity in the fresh products sections. It's suitable for product presentation with both crates and as bulk. The display angle is ergonomically adjusted to present the products in the highest visibility.



Oval shelf to highlight any desired fresh product.



Basket shelf to display various fresh products.

Optional accessories used in Vegy are also compatible with "Fresh", "Pure", "Prusa" and "Greens" models.

Model & Parts	Height ( H )	Depth ( D )	Length ( L )	Level	Lighting	Coating
VEGY WALL UNIT DOUBLE LEVEL (STD)	2267	1093	850 / 1250	2	Optional	Wood / Metal
VEGY WALL UNIT DOUBLE LEVEL (Narrow)	2267	693	850 / 1250	2	Optional	Wood / Metal
Accessories Bar	40	20	850 / 1250	-	-	Powder Coating
Half Oval Shelf ATG	40	450 / 500	600	-	-	Powder Coating
Wire Basket ATG	150	400	300	-	-	Powder Coating





Wooden Covered

Authentic Pattern

Modern Pattern



Oval shelf to highlight any desired fresh product.

## PURE

Pure brings ergonomics and richness together in fresh product display, offering flexible design, coating and size options. Wood and metal coating options make the product adaptable to your concept design. The combination of the wall and the middle section provides an integrity in the fresh products sections. It's suitable for product presentation with both crates and as bulk. The display angle is ergonomically adjusted to present the products in the highest visibility.



Basket shelf to display various fresh products.

Optional accessories used in Pure are also compatible with "Fresh", "Vegy", "Prusa" and "Greens" models.

● RAL 7016 ● OAK

Model & Parts	Height ( H )	Depth ( D )	Length ( L )	Level	Lighting	Coating
PURE ONE LEVEL UNIT	2267	1259	850 / 1250	1	Optional	Wood / Metal
PURE CORNER UNIT	2267	1259	-	1	-	Wood / Metal
Accessories Bar	40	20	850 / 1250	-	-	Powder Coating
Half Oval Shelf ATG	40	450 / 500	600	-	-	Powder Coating
Wire Basket ATG	150	400	300	-	-	Powder Coating





Basket shelf to display various fresh products.



Oval shelf to highlight any desired fresh product.

## FRESH

Fresh is a multi-functional and content-rich aisle solution with various accessory options. It can be used both as a wall and as a middle display unit. With its low depth, it adapts to any space. Thanks to its ergonomic structure and optimum height, it is a dynamic system that enables the creation of different display areas in harmony with any store concept.

Optional accessories used in Fresh are also compatible with "Pure", "Vegy", "Prusa" and "Greens" models.

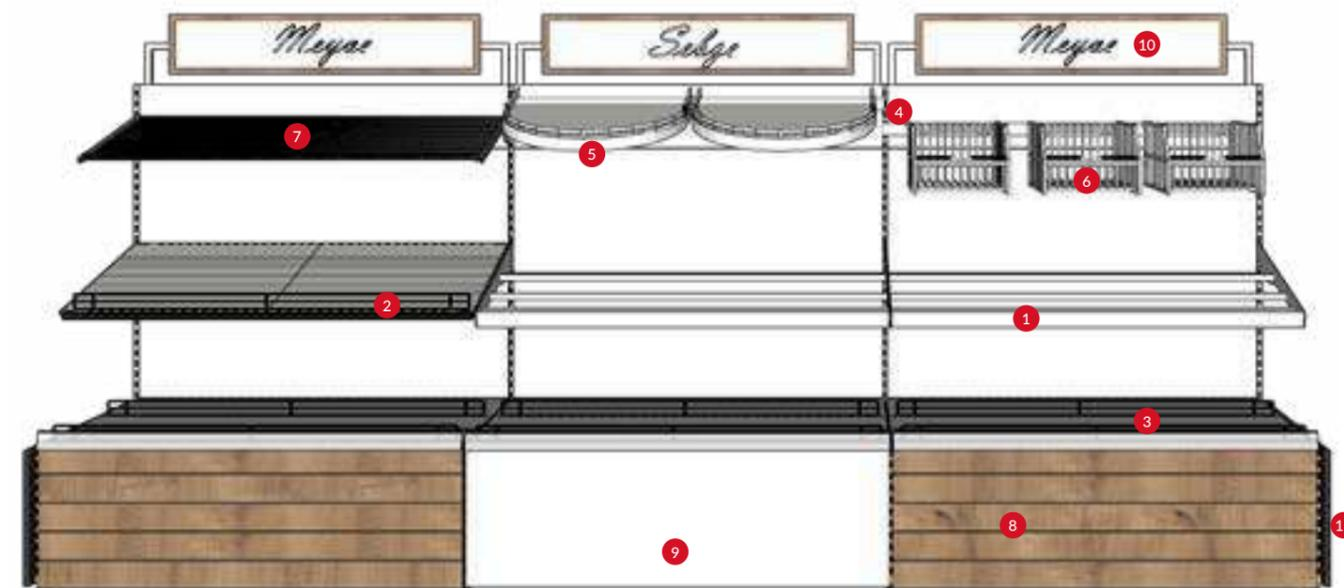

● RAL 7016 ● OAK

No	Model & Parts	Height ( H )	Depth ( D )	Length ( L )	Level	Lighting	Coating
-	FRESH WALL UNIT BODY	1430	740	950 / 1250	Optional	Optional	Wood / Metal
1	Profile Shelf	40	400 / 600	950 / 1250	-	-	Powder Coating
2	Metal Shelf	40	450 / 500 / 600	950 / 1250	-	-	Powder Coating
3	Metal Shelf Front Grid	50	-	950 / 1250	-	-	Powder Coating
4	Accessories Bar	40	20	950 / 1250	-	-	Powder Coating
5	Half Oval Shelf ATG	40	450 / 500	600	-	-	Powder Coating
6	Wire Basket ATG	150	400	300	-	-	Powder Coating
7	Sloping Wire Shelf	-	400/500	950 / 1250	-	-	Powder Coating
8	Wooden Front Panel	450	-	950 / 1250	-	-	Wooden
9	Metal Front Panel	450	-	950 / 1250	-	-	Powder Coating
10	Wooden Canopy with Blackboard	200	-	950 / 1250	-	-	Wooden
11	Wooden Side Panel	450	740	-	-	-	Wooden

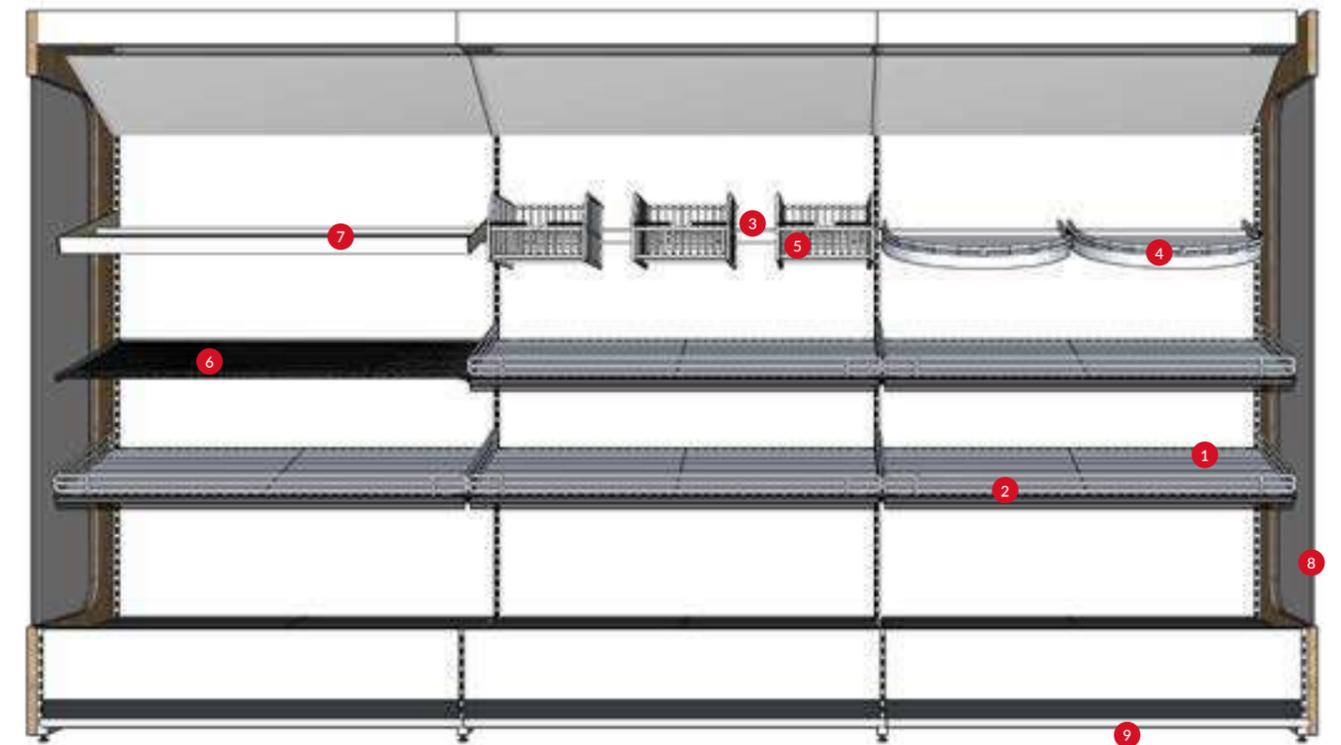

● RAL 7016 ● OAK

No	Model & Parts	Height ( H )	Depth ( D )	Length ( L )	Level	Lighting	Coating
-	GREENS WALL UNIT BODY	2250	680	950 / 1250	Optional	Optional	Wood / Metal
1	Metal Shelf	40	450 / 500	950 / 1250	-	-	Powder Coating
2	Metal Shelf Front Grid	50	-	950 / 1250	-	-	Powder Coating
3	Accessories Bar	40	20	950 / 1250	-	-	Powder Coating
4	Half Oval Shelf ATG	40	450 / 500	600	-	-	Powder Coating
5	Wire Basket ATG	150	400	300	-	-	Powder Coating
6	Sloping Wire Shelf	-	400/500	950 / 1250	-	-	Powder Coating
7	Profile Shelf	40	400 / 600	950 / 1250	-	-	Powder Coating
8	Wooden Side Panel	2250	700	-	-	-	Wooden
9	Barrier	-	-	950 / 1250	-	-	Powder Coating

## GREENS

Greens offers an effective presentation and stylish appearance in packaged fresh product display. Vertical and multi-storey shelf options allow highly efficient display with visual appeal in stores with a large product variety and packaged display density. With its different shelf options and accessories, it provides a wealth of display and convenience suitable for all kinds of fresh products.

Optional accessories used in Greens are also compatible with "Pure", "Vegy", "Prusa" and "Fresh" models.



Oval shelf to highlight any desired fresh product.



Basket shelf to display various fresh products.

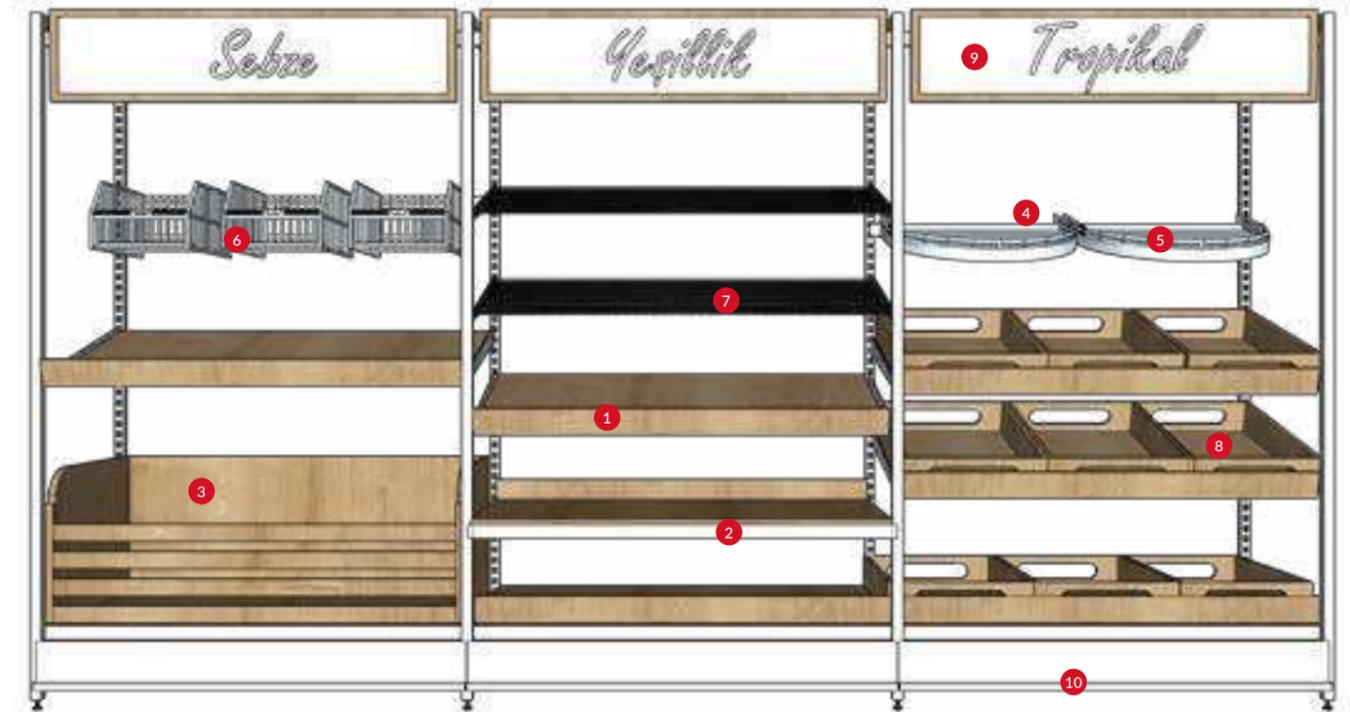

● RAL 7016 ● OAK



Oval shelf to highlight any desired fresh product.



Basket shelf to display various fresh products.

## PRUSA

The Prusa fresh product display brings a minimal and powerful style to the presentation of fruit and vegetables. It allows you to make a flexible and rich display in narrow spaces with different shelf and accessory options. It is very easy to install with its modular structure.

Optional accessories used in Prusa are also compatible with "Pure", "Vegy", "Greens" and "Fresh" models.

No	Model & Parts	Height ( H )	Depth ( D )	Length ( L )	Level	Lighting	Coating
-	PRUSA WALL UNIT BODY	2000	680	950 / 1250	Optional	Optional	*
1	Sloping Wooden Shelf	50	600	950 / 1250	-	-	Wooden
2	Wooden Shelf with Beam	18	600	950 / 1250	-	-	Wooden
3	Wooden Basket	400	600	950 / 1250	-	-	Wooden
4	Accessories Bar	40	20	950 / 1250	-	-	Powder Coating
5	Half Oval Shelf ATG	40	450 / 500	600	-	-	Powder Coating
6	Wire Basket ATG	150	400	300	-	-	Powder Coating
7	Sloping Wire Shelf	-	400/500	950 / 1250	-	-	Powder Coating
8	Wooden Display Box	100	400	600	-	-	Wooden
9	Wooden Canopy with Blackboard	200	-	950 / 1250	-	-	Wooden
10	Barrier	-	-	950 / 1250	-	-	Powder Coating

## PURE MIDDLE UNIT

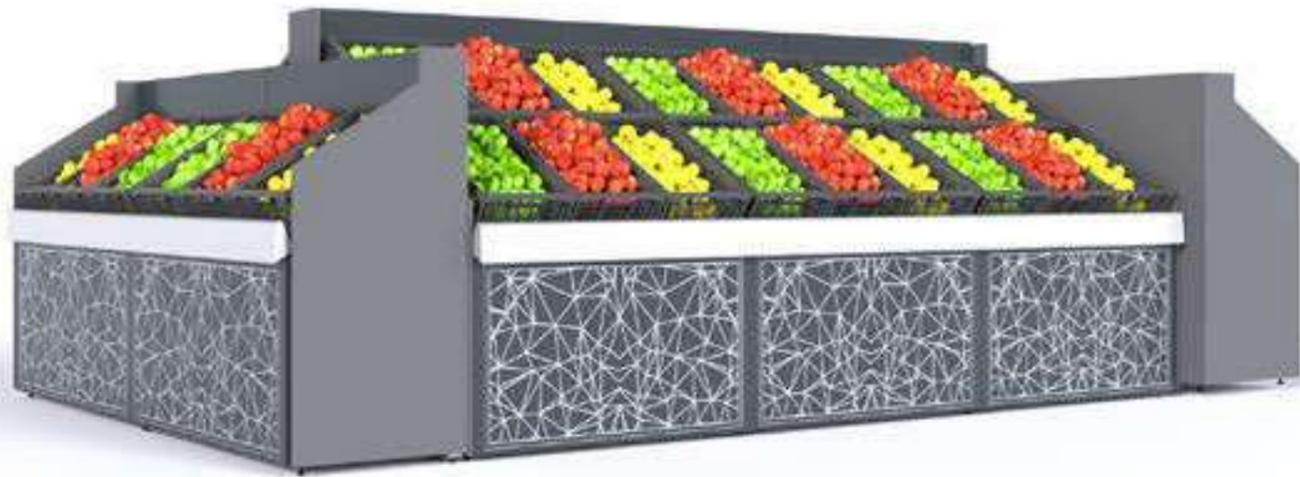

● RAL 7016 ● OAK

Model & Parts	Height ( H )	Depth ( D )	Length ( L )	Box	Lighting	Coating
PURE DOUBLE SIDED MIDDLE UNIT	1450	1100 + 1100	1250	6 + 6	Optional	Wood / Metal
PURE DOUBLE SIDED MIDDLE UNIT	1450	650 + 650	1250	3 + 3	Optional	Wood / Metal
PURE GONDOLA	1250	600	2000	5	Optional	Wood / Metal
PURE GONDOLA	1250	600	1250	3	Optional	Wood / Metal
Half Oval Shelf ATG	40	450 / 500	600	-	-	Powder Coating
Wire Basket ATG	150	400	300	-	-	Powder Coating
Accessories Bar	40	20	950 / 1250	-	-	Powder Coating

## FRESH MIDDLE UNIT



● RAL 7016 ● OAK

Model & Parts	Height ( H )	Depth ( D )	Length ( L )	Level	Lighting	Coating
FRESH DOUBLE SIDED MIDDLE UNIT	1430	700 + 700	950 / 1250	Optional	Optional	Wood / Metal
Profile Shelf	40	400 / 600	950 / 1250	-	-	Powder Coating
Metal Shelf	40	450 / 500 / 600	950 / 1250	-	-	Powder Coating
Metal Shelf Front Grid	50	-	950 / 1250	-	-	Powder Coating
Accessories Bar	40	20	950 / 1250	-	-	Powder Coating
Half Oval Shelf ATG	40	450 / 500	600	-	-	Powder Coating
Wire Basket ATG	150	400	300	-	-	Powder Coating
Sloping Wire Shelf	-	400/500	950 / 1250	-	-	Powder Coating
Wooden Front Panel	450	-	950 / 1250	-	-	Wooden
Metal Front Panel	450	-	950 / 1250	-	-	Powder Coating
Wooden Canopy with Blackboard	200	-	950 / 1250	-	-	Wooden
Wooden Side Panel	450	1470	-	-	-	Wooden





## MIDDLE STAND

To support your fruit & vegetable presentation, the best way you can take is to use the empty spaces in these sections. Sova offers stylishly designed and ergonomic display stands, to help you enrich your store atmosphere and make effective presentations.



### S-GON MIDDLE STAND

(h x d x l)

Main Stand: 1050 x 650 x 1250 mm  
 Wooden Side Shelves: 420 x 1250 mm  
 Metal Side Shelf: 250 x 650 mm

COLOR OPTIONS

- RAL 7016
- OAK



### F&V DISPLAY BIN

(h x d x l)

850 x 1000 x 1000 mm

COLOR OPTIONS

- RAL 7016
- OAK



### SMART F&V MIDDLE STAND

(h x d x l)

850 x 1000 x 1000 mm

COLOR OPTIONS

- RAL 7016
- WOODEN



### SCALE STAND

(h x d x l)

850 x 600 x 600 mm  
 850 x 600 x 1000 mm

COLOR OPTIONS

- ANTHRACITE
- OAK



### WOODEN DISPLAY CRATE

(h x d x l)

100 x 400 x 600 mm



### PLASTIC DISPLAY CRATE

(h x d x l)

100 x 400 x 600 mm  
 150 x 400 x 600 mm  
 200 x 400 x 600 mm  
 250 x 400 x 600 mm

- ANTHRACITE
- GREEN
- BLUE

# BAKERY DISPLAYS



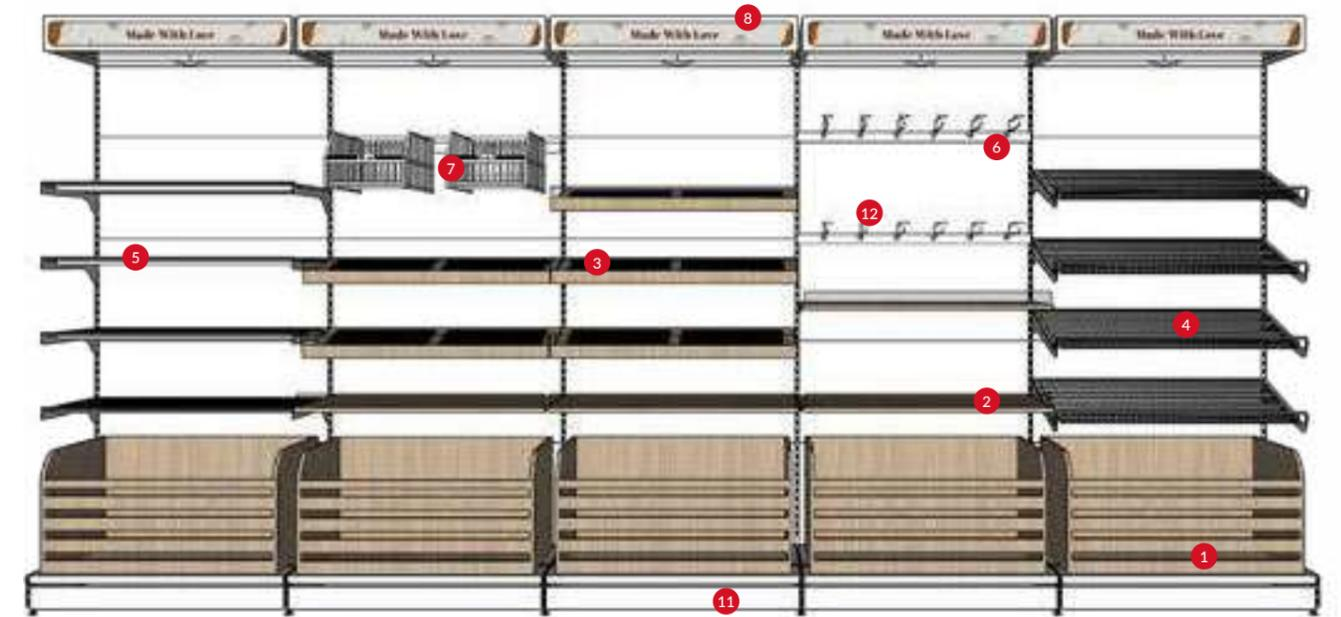

- RAL 7016
- RAL 9010
- OAK



Kios Middle Unit

## KIOS

With its multifunctional structure, Kios Bakery Display provides great flexibility in the display of baked products. It offers both a functional display and a visual feast in your store with its many re-configurable and adjustable shelves and accessories. All the accessories in both the wall and the gondola units are compatible with each other.

No	Model & Parts	Height ( H )	Depth ( D )	Length ( L )	Level	Lighting	Coating
-	KIOS WALL UNIT BODY	2270	500	750 / 950	Optional	Optional	Powder Coating
-	KIOS MIDDLE UNIT BODY	1430	1070	750 / 950	Optional	Optional	Powder Coating
1	Bakery Wooden Basket	400	500	750 / 950	-	-	Wooden
2	Wooden Shelf	18	450	750 / 950	-	-	Wooden
3	Wooden Grid Shelf	50	450	750 / 950	-	-	Wooden
4	Sloping Wire Shelf	40	400	750 / 950	-	-	Powder Coating
5	Wire Basket	40	400	750 / 950	-	-	Powder Coating
6	Accessories Bar	40	20	750 / 950	-	-	Powder Coating
7	Wire Basket ATG	150	400	300	-	-	Powder Coating
8	Illuminated Canopy	200	500	750 / 950	-	-	Powder Coating
9	Middle Unit Wooden Sloping Basket	300	500	750 / 950	-	-	Wooden
10	Wooden Canopy with Blackboard	200	-	750 / 950	-	-	Wooden
11	Metal Plinth	200	-	750 / 950	-	-	Powder Coating
12	Wire Hook ATG with Label Holder	-	300	-	-	-	Chrome

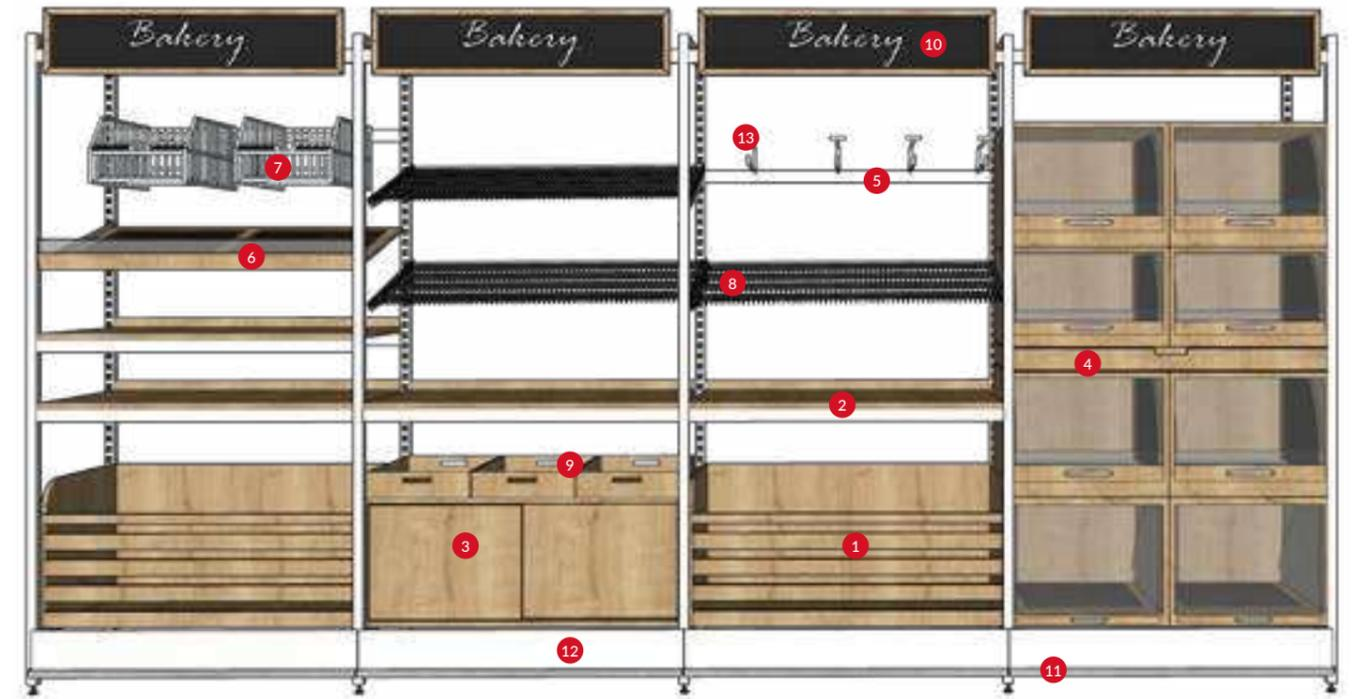

## MONTANIA

MONTANIA Bakery Display offers a minimal but powerful look in bakery presentation. It allows you to make a flexible and rich display in narrow spaces with different shelf and accessory options. It provides easy installation with its modular structure.



### S-GON MIDDLE STAND

Add color to your products with an effective S-GON middle stand with four-way presentations.

(h x d x l)

Body: 1050 x 650 x 1250 mm  
 Wooden Side Shelves: 420 x 1250 mm  
 Metal Side Shelf: 250 x 650 mm

● RAL 7016 ● OAK

No	Model & Parts	Height ( H )	Depth ( D )	Length ( L )	Level	Lighting	Coating
-	MONTANIA WALL UNIT BODY	2000	680	750 / 950	Optional	Optional	Powder Coating
1	Bakery Wooden Basket	400	500	750 / 950	-	-	Wooden
2	Wooden Shelf with Beam	18	500	750 / 950	-	-	Wooden
3	Wooden Cabinet	400	500	750 / 950	-	-	Wooden
4	Cake Cabinet	1800	500	750 / 950	-	-	Wooden
5	Accessories Bar	40	20	750 / 950	-	-	Powder Coating
6	Wooden Grid Shelf	50	400	750 / 950	-	-	Wooden
7	Wire Basket ATG	150	400	300	-	-	Powder Coating
8	Sloping Wire Shelf	-	400/500	750 / 950	-	-	Powder Coating
9	Wooden Display Box	100	500	300	-	-	Wooden
10	Wooden Canopy with Blackboard	200	-	750 / 950	-	-	Wooden
11	Barrier	-	-	950 / 1250	-	-	Powder Coating
12	Metal Plinth	170	-	750 / 950	-	-	Powder Coating
13	Wire Hook ATG with Label Holder	-	300	-	-	-	Chrome

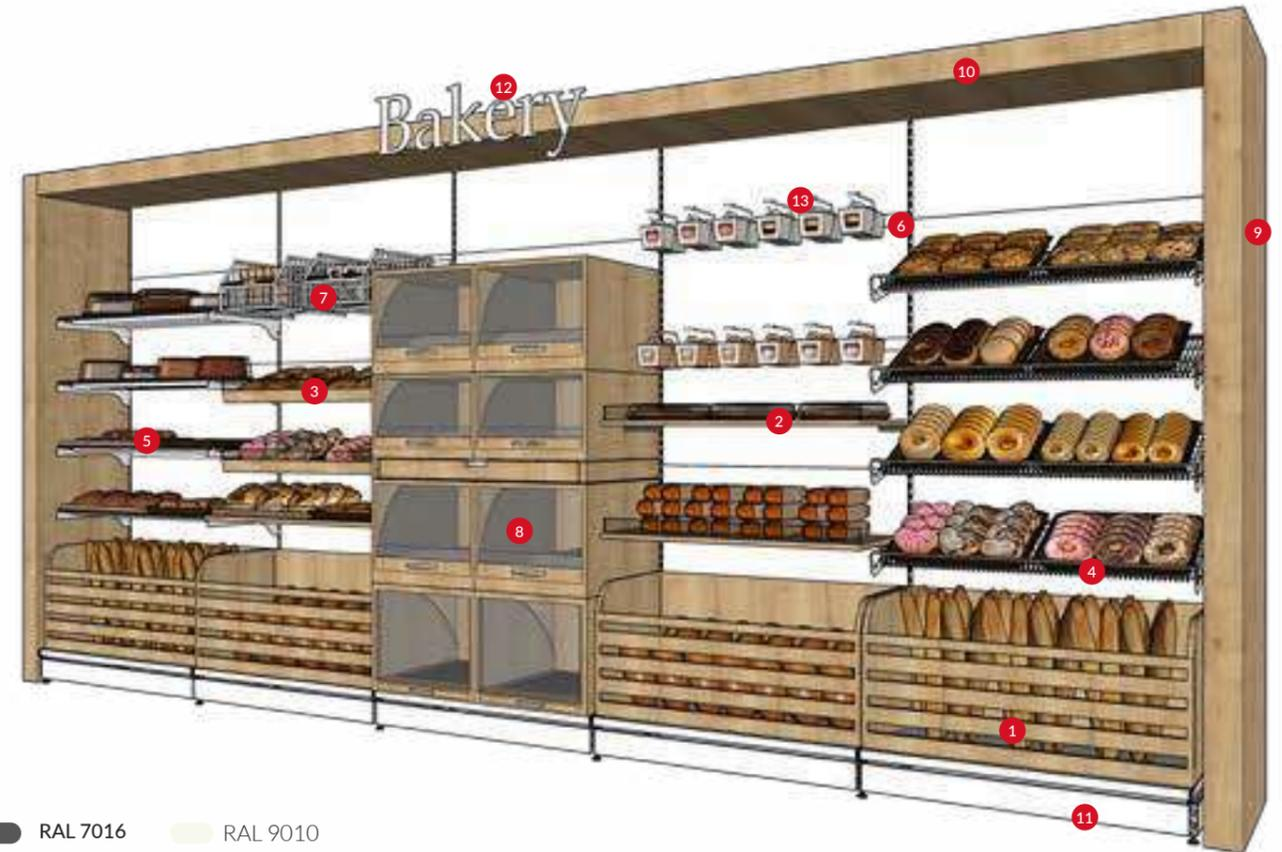

- RAL 7016
- RAL 9010
- OAK



Nikea Cake / Bread Cabinet

## NIKEA

With its multifunctional structure, the NIKEA Bakery Unit provides great flexibility in the display of bakery products. You can get an efficient display and stylish visuality in your store with many shelves and accessories that can be adjusted and changed in themselves. All accessories used in both wall and middle sections are compatible with each other.

No	Model & Parts	Height ( H )	Depth ( D )	Length ( L )	Level	Lighting	Coating
-	NIKEA WALL UNIT BODY	2270	500	750 / 950	Optional	Optional	Powder Coating
1	Bakery Wooden Basket	400	500	750 / 950	-	-	Wooden
2	Wooden Shelf	18	400	750 / 950	-	-	Wooden
3	Wooden Grid Shelf	50	400	750 / 950	-	-	Wooden
4	Sloping Wire Shelf	40	400	750 / 950	-	-	Powder Coating
5	Wire Shelf	40	400	750 / 950	-	-	Powder Coating
6	Accessories Bar	40	20	750 / 950	-	-	Powder Coating
7	Wire Basket ATG	150	400	300	-	-	Powder Coating
8	Cake Cabinet	1800	500	750 / 950	4	-	Wooden
9	Wooden Side Column	2270	600	100	-	-	Wooden
10	Wooden Top Column	100	500	Değişken	-	-	Wooden
11	Metal Plinth	170	-	750 / 950	-	-	Powder Coating
12	Letter Group	200	-	-	-	-	Wooden
13	Wire Hook ATG	-	300	-	-	-	Chrome
-	NIKEA CAKE / BREAD CABINET	1800	700	800	-	-	Wooden



**SHELF**  
SYSTEMS



## E25 METAL SHELF SYSTEM

### TECHNICAL DETAILS

#### STANDARD COLOR OPTIONS

- RAL 9010
- RAL 9001
- RAL 7035
- RAL 7024

#### COLORED PARTS

- RAL 1023
- RAL 2004
- RAL 3020
- RAL 5010
- RAL 6018

#### UNIT DIMENSIONS

H : 1000 - 1400 - 1600 - 1800 - 2000 - 2200 - 2400 mm  
 D : 200 - 300 - 400 - 500 - 600 - 700 mm  
 L : 500 - 665 - 700 - 900 - 1000 - 1250 - 1330 mm

#### OPTIONAL COLORS

Alternative colors are available depending on the customer's request.

You can contact our sales consultants for alternative colors you choose from the RAL catalogue.

### POWDER COATING FEATURES

Electrostatic Epoxy Polyester Powder Paint

Thin Metal Rack with U  
Channel for Price Strip



25 Pitch System



Reinforced Bolt-Nut  
Connected Base Leg System



No	Parts	Height ( H )	Depth ( D )	Length ( L )	Section mm.	Thickness
1	E25 Upright	970 - 1270 - 1233 - 1650 - 1850 - 2200 - 2400 - 2800	-	-	30x60 / 30x80 / 30x100	2,5 mm
2	E25 Base Leg	-	300 - 400 - 500 - 600 - 700	-	-	-
3	E25 Back Panel	500 - 400 - 420 - 220	-	665 - 700 - 900 - 1000 - 1250 - 1330	-	0,6 mm
4	E25 Perforated Back Panel	200 - 300 - 400 - 500	-	665 - 700 - 900 - 1000 - 1250 - 1330	-	0,9 mm
5	E25 Metal Shelf	-	300 - 400 - 500 - 600 - 700	665 - 700 - 900 - 1000 - 1250 - 1330	-	0,7 mm
6	E25 Bracket	-	300 - 400 - 500 - 600	-	-	2,5 mm
7	E25 Plinth	-	-	665 - 700 - 900 - 1000 - 1250 - 1330	-	0,6 mm
8	E25 Price Strip	-	-	665 - 700 - 900 - 1000 - 1250 - 1330	-	-



## S35 METAL SHELF SYSTEM

### TECHNICAL DETAILS

#### STANDARD COLOR OPTIONS

- RAL 9016
- RAL 7016
- RAL 7035

#### COLORED PARTS

- RAL 1023
- RAL 2004
- RAL 3020
- RAL 5010
- RAL 6018

#### UNIT DIMENSIONS

H : 1010 - 1220 - 1450 - 1600 - 1850 - 2050 - 2270 - 2480 mm  
 D : 300 - 400 - 500 - 600 mm  
 L : 550 - 750 - 950 - 1250 mm

#### OPTIONAL COLORS

Alternative colors are available depending on the customer's request.

You can contact our sales consultants for alternative colors you choose from the RAL catalogue.

### POWDER COATING FEATURES

Electrostatic Epoxy Polyester Powder Paint

Labeled Metal Shelf  
Perforated Panel System  
with Accessory Attachment



35 Pitch System



Reinforced cast connection  
base leg system



No	Parts	Height ( H )	Depth ( D )	Length ( L )	Section mm.	Thickness
1	S35 Upright	1010 - 1220 - 1450 - 1600 - 1850 - 2050 - 2270 - 2480	-	-	30x70	2 mm
2	S35 Base Leg	-	300 - 400 - 500 - 600	-	-	-
3	S35 Back Panel	420 - 210	-	550 - 750 - 950 - 1250	-	0,6 mm
4	S35 Perforated Back Panel	420	-	550 - 750 - 950 - 1250	-	1 mm
5	S35 Metal Shelf	-	300 - 400 - 500 - 600	550 - 750 - 950 - 1250	-	0,7 mm
6	S35 Bracket	-	300 - 400 - 500 - 600	-	-	2,5 mm
7	S35 Plinth	-	-	550 - 750 - 950 - 1250	-	0,6 mm
8	S35 Price Strip	-	-	550 - 750 - 950 - 1250	-	-





## PROMOTIONAL STANDS

### METAL SHELF SYSTEM



Sova's special display and promotional stands for your brand and products will make you stand out.

Providing easy shipping and installation with their modular structure, Sova's promotional stands ensures the most effective display for your products, along with various combinations and shelf, accessory and ad space alternatives.

You can create your desired stand for your brand by contacting our sales consultants.

Highlight your brand with illuminated or non-illuminated canopy options.

#### OPTIONAL COLORS

Any RAL color matching with your brand identity can be used.

### POWDER COATING FEATURES

Electrostatic Epoxy Polyester Powder Paint

No	Model & Parts	Height ( H )	Depth ( D )	Length ( L )	Notes
-	Promotional Stand Main T1	1850 - 2050 - 2270	300 - 400 - 500 - 600	550 - 750 - 950 - 1250	With Plain Back Panel
-	Promotional Unit Body T2	1850 - 2050 - 2270	300 - 400 - 500 - 600	550 - 750 - 950 - 1250	With Perforated Back Panel
1	Metal Shelf Set	-	300 - 400 - 500 - 600	550 - 750 - 950 - 1250	Powder Coating
2	Wire Shelf Set	-	300 - 400	550 - 750 - 950 - 1250	Powder Coating
3	Sloping Wire Shelf Set	-	300 - 400	550 - 750 - 950 - 1250	Powder Coating
4	Basket Shelf DG	200	300 - 400	550 - 750 - 950 - 1250	Powder Coating
5	Over-Shelf Basket	250	300 - 400 - 500	350	Powder Coating
6	Bar	-	-	550 - 750 - 950 - 1250	Chrome
7	Wire Hook ATG	-	250 - 300 - 400	-	Chrome
8	Wire Hook DSG	-	250 - 300	-	Chrome
9	Curved Top Canopy	200	100	550 - 750 - 950 - 1250	Foil Printed Logo Area
10	Top Canopy with Backlight Type 1	100	300 - 400 - 500	550 - 750 - 950 - 1250	Laser Cut Logo Area
11	Top Canopy with Backlight Type 2	100	300 - 400 - 500	550 - 750 - 950 - 1250	Plexiglass Logo Area
12	Box Top Canopy with Backlight	300	100	550 - 750 - 950 - 1250	Plexiglass Logo Area



## 25D SUPPORTED SHELF SYSTEM

### 1 ▶ E25 Upright

(h)  
1820 mm  
2045 mm  
2245 mm  
2470 mm

### 2 ▶ E25 Base Leg

(h x d)  
130 x 600 mm  
130 x 700 mm  
130 x 800 mm

### 3 ▶ Front Upright

(h)  
1820 mm  
2045 mm  
2245 mm  
2470 mm

Edge  
30x30 mm - 1,5 mm

### 4 ▶ E25 Supported System Bracket

(d)  
600 mm  
700 mm  
800 mm

✱ Back panels and shelves are used from standard E25 unit parts.



## TOP FREEZER UNIT

### 1 ▶ Single Sided Welded Foot

(h X d)  
1395 x 600 mm  
1620 x 600 mm

### 1 ▶ Double Sided Welded Foot

(h X d)  
1395 x 1200 mm  
1620 x 1200 mm

### 2 ▶ Interconnection for Upright

(l)  
1000 mm  
1250 mm

### 3 ▶ Interconnection for Leg

(l)  
1000 mm  
1250 mm

✱ Back Panels and shelves are used from unit parts.



**METAL GONDOLA SIDE STAND**

**Gondola Side Stand Main**

(h x d x l)  
 1850 x 200 x 400 mm  
 1850 x 200 x 500 mm  
 2060 x 200 x 400 mm  
 2060 x 200 x 500 mm

**Gondola Side Stand Shelf**

(d x l)  
 180 x 400 mm  
 180 x 500 mm

**Wire Hook with Label Holder DSG**

(d)  
 150 mm

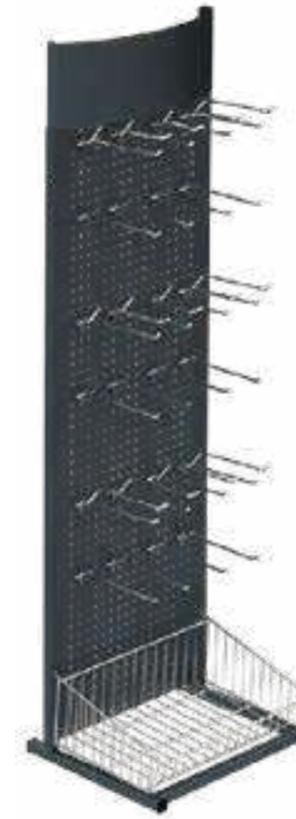

**UNIVERSAL PRODUCT STAND**

**Universal Product Stand Basket**

(d x l)  
 500 x 750 mm  
 500 x 950 mm

**Universal Product Stand Main**

(h x d x l)  
 2015 x 500 x 750 mm  
 2015 x 500 x 950 mm

**Wire Hook with Label Holder DSG**

(d)  
 250 mm  
 300 mm

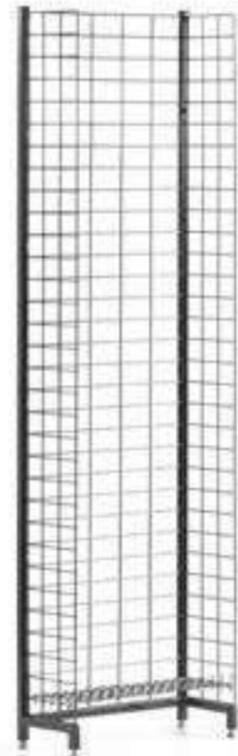

**WIRE GONDOLA SIDE STAND**

**Wire Gondola Side Stand Main**

(h x d x l)  
 1850 x 200 x 400 mm  
 1850 x 200 x 500 mm  
 2060 x 200 x 400 mm  
 2060 x 200 x 500 mm

**Wire Gondola Side Stand Shelf**

(d x l)  
 180 x 400 mm  
 180 x 500 mm

**Wire Hook with Label Holder MG**

(d)  
 150 mm



**FRUIT & VEGETABLE STAND**

**Fruit & Vegetable Stand Main**

(h x d x l)  
 2015 x 600 x 1250 mm

**Fruit & Vegetable Stand Profile Shelf**

(d x l)  
 600 x 1250 mm

# LIGHT DUTY STORAGE SHELVES

## F30 LIGHT DUTY STORAGE SHELVES

F30 System is used for the storage of light and medium weight product groups. It can easily carry loads up to 200 kg per shelf. The F30 System can be installed side by side. It is built up by only three separate parts and can easily be assembled without any need for bolts and nuts.



### F30 Beam

(l)  
900 mm  
1200 mm  
1500 mm  
Beam Edge  
30 x 30 x 1,5 mm

### F30 Tray Shelf

(h x d x l)  
20 x 400 x 300 mm  
20 x 500 x 300 mm  
Thickness  
0,8 mm



### F30 Frame

(h x d)  
1600 x 400 mm  
1600 x 500 mm  
2000 x 400 mm  
2000 x 500 mm  
Profile Edge  
30 x 30 x 1,5 mm



## BOLTED RACK SYSTEM

It is a versatile rack system that is used for display, light storage and archiving purposes. It consists of only 2 parts: the profile (upright) and the metal shelf. It is shipped out disassembled and assembled with bolts and nuts. This rack system, which has an average carrying capacity of 80 kg per shelf, is used frequently for archiving and filing purposes. Alternative placements can be achieved in project layouts by using different sizes.



### Bolted L Upright

(h x d x l)  
1000 x 40 x 40 mm  
1500 x 40 x 40 mm  
2000 x 40 x 40 mm  
2500 x 40 x 40 mm

### Bolt

### Nut

Profile Section  
1,5 mm / 2 mm

### Bolted Shelf

Thickness  
0,6 mm / 0,7 mm / 1 mm



### (h x d x l)

20 x 310 x 600 mm  
20 x 310 x 750 mm  
20 x 310 x 910 mm

20 x 430 x 600 mm  
20 x 430 x 750 mm  
20 x 430 x 910 mm

20 x 590 x 600 mm  
20 x 590 x 750 mm  
20 x 590 x 910 mm



# F60 MINIRACK SYSTEM

### FRAME COLOR OPTIONS

- RAL 5010
- RAL 7016
- RAL 7035

### BEAM COLOR OPTIONS

- RAL 1023
- RAL 2004
- RAL 3020
- RAL 5010

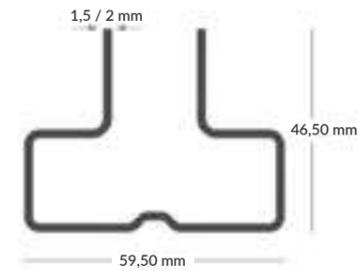
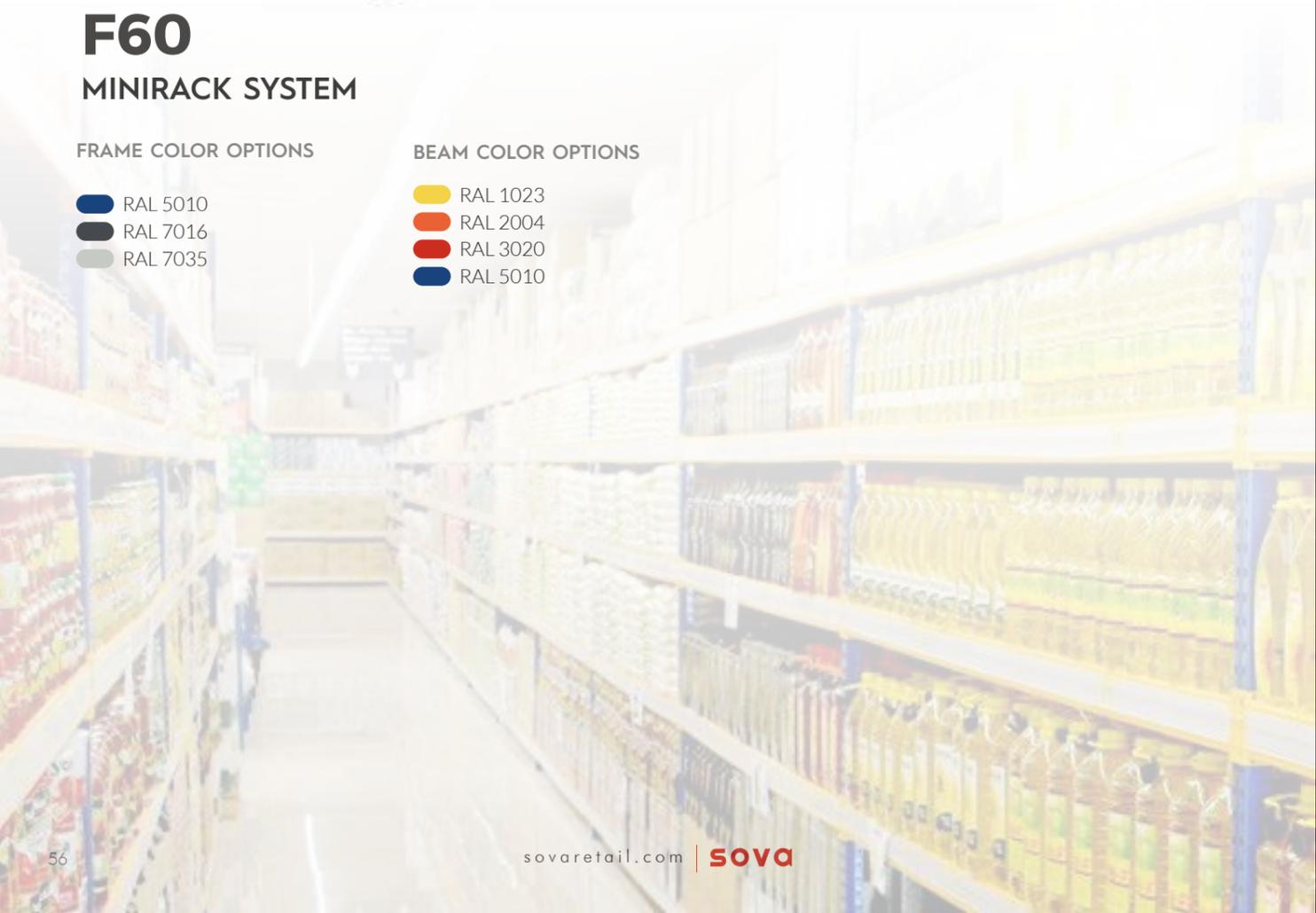

F60 MR Frame Profile Section

F60 SECURITY PIN



F60 STEEL PEG



F60 BASE PLATE



No	Parts	Height ( H )	Depth ( D )	Length ( L )	Section mm.	Thickness
1	F60 Minirack Frame	1500 - 2000 - 2250 - 2500 - 2750 - 3000 - 3500	500 - 600 - 700 - 800	-	-	1,5 / 2 mm
2	F60 Minirack Twin Frame	1500 - 2000 - 2250 - 2500 - 2750 - 3000 - 3500	900 - 1000 - 1200	-	-	1,5 / 2 mm
3	F60 Minirack Base Plate	-	-	-	-	-
4	F60 Minirack Steel Peg	-	-	-	-	-
5	F60 Z Beam	-	-	1000 - 1250 - 1500 - 1750 - 2000 - 2500	30x66	1,5 / 2 mm
6	F60 Omega Beam	-	-	1000 - 1250 - 1500 - 1750 - 2000 - 2500	30x66	1,5 / 2 mm
7	F60 Box Beam 40x80	-	-	1000 - 1250 - 1500 - 1750 - 2000 - 2500	40x80	2 mm
8	F60 G Beam 40x80	-	-	1000 - 1250 - 1500 - 1750 - 2000 - 2500	40x80	2 mm
9	F60 Pipe Beam	-	-	1000 - 1250 - 1500 - 1750 - 2000	Ø 21	1,5 mm
10	F60 Security Pin	-	-	-	-	-
11	F60 Internal Tray 20 mm	-	500 - 600 - 700 - 800 - (900 - 1000 - 1200)*	250 - 300	-	0,8 / 1 mm
12	F60 External Tray 20 mm	-	500 - 600 - 700 - 800 - (900 - 1000 - 1200)*	250 - 300	-	0,8 / 1 mm

\* Dimensions 900 / 1000 and 1200 are used in the Twin Frame System.

FRAME CONNECTION DETAILS



F60 FRAME WALL CONNECTION

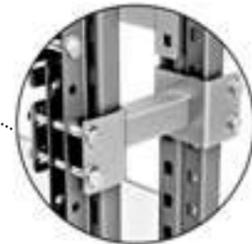

F60 FRAME INTERCONNECTION



F60 TWIN FRAME RACK SYSTEM

If a deeper configuration is required, the unit depth can be increased by using the twin frames. In this case, savings are also achieved in the number of beams and trays.

Beam Edge	Beam Floor Load Carrying Capacities						
	1000 mm	1250 mm	1500 mm	1750 mm	2000 mm	2250 mm	2500 mm
F60 Z BEAM 66. ( 1,5 mm )	640 Kg	600 Kg	560 Kg	480 Kg	420 Kg	410 Kg	400 Kg
F60 Z BEAM 66. ( 2 mm )	810 Kg	760 Kg	710 Kg	600 Kg	550 Kg	440 Kg	420 Kg
F60 OMEGA BEAM 30x60 ( 1,5 mm )	1150 Kg	860 Kg	660 Kg	550 Kg	500 Kg	460 Kg	410 Kg
F60 OMEGA BEAM 30x60 ( 2 mm )	1200 Kg	1060 Kg	840 Kg	700 Kg	620 Kg	580 Kg	560 Kg
F60 BOX BEAM 40x60 ( 1,5 mm )	1200 Kg	860 Kg	700 Kg	660 Kg	540 Kg	500 Kg	440 Kg
F60 BOX BEAM 40x60 ( 2 mm )	1340 Kg	1100 Kg	880 Kg	770 Kg	640 Kg	600 Kg	550 Kg
F60 BOX BEAM 40x80 ( 2 mm )	-	1900 Kg	1600 Kg	1350 Kg	1200 Kg	1170 Kg	1000 Kg
F60 BOX G BEAM 40x80 ( 2 mm )	-	1950 Kg	1650 Kg	1400 Kg	1300 Kg	1250 Kg	1070 Kg



# FARMARACK DRAWER SYSTEM



## FARMARACK DRAWER SYSTEM

High capacity drug storage with telescopic full swing drawers. Keep your sales space intact. Easy access to all drugs with telescopic ladder and labeling system.

(h x d x l)

2000 x 1000 x 420 mm  
2000 x 1200 x 420 mm

Each module is 450 mm wide. To create a unit of the desired size, a certain number of modules should be added side by side. An additional upright is added at the end of each set of units. Each unit is also dressed up with a wooden cover.

FARMARACK ADDITIONAL UPRIGHT

FARMARACK WOODEN COVER

COLOR OPTIONS

Metal Color Options  RAL 9016  RAL 7046  
Wooden Color Options  OAK  WHITE

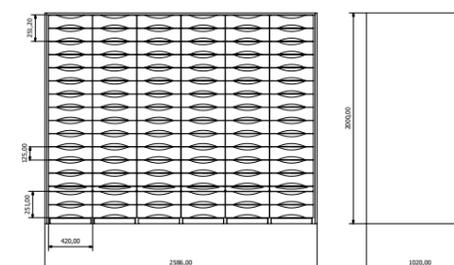

A standard drawer column has a total of 11 single drawers, 2 double drawers and a telescopic ladder. Farmarack is a modular system. Any desired unit size can be created by adding modules of 450 mm side by side. The side, top and back of the unit are covered by wooden plates of 18 mm medium-density fiberboard (MDF).

Shipped out as completely disassembled and installed on site.

### Single Telescopic Drawer

80 kg load capacity with bearing supported rails.  
Drawer compartments.  
Open drawer depth 900 / 1100 mm.  
Drawer height: 125 mm.

### Double Telescopic Drawer

80 kg load capacity with bearing supported rails.  
Drawer compartments.  
Open drawer depth 900 / 1100 mm.  
Drawer height: 250 mm.

### Telescopic Ladder

Open/Close with rail mechanism.  
120 kg load capacity.



Note : Drawers can be painted in various colors. Please contact Sovo sales staff for available options.



12  
TAKSİT  
FIRSATI

Beyaz Eşya

Batarya

Mutfak Tasarımı

Kapak seçenekleri

DISPLAY  
EQUIPMENT

29

149

109

beko

Washing machine and other appliances





DISPLAY BASKET DELTA

(h x d x l)  
 850 x 600 x 800 mm  
 850 x 800 x 1200 mm



TOP SHELF SET

(h x d x l)  
 700 x 320 x 800 mm  
 700 x 320 x 1200 mm



2 swivel – 2 with brake  
 100 mm casters



DISPLAY BASKET ALFA

(h x d x l)  
 850 x 400 x 600 mm  
 850 x 600 x 800 mm  
 850 x 800 x 800 mm  
 850 x 800 x 1200 mm



Standard Profile



Supported Profile



Optional Wheels



DISPLAY BASKET BETA

(h x d x l)  
 850 x 600 x 800 mm  
 850 x 800 x 800 mm  
 850 x 800 x 1200 mm



Standard Profile



Supported Profile



Optional Wheels



DISPLAY BASKETOMICRON

(h x d x l)  
 850 x 600 x 800 mm  
 850 x 800 x 1200 mm



DISPLAY BASKET GAMA

(h x d x l)  
 850 x 600 x 800 mm  
 850 x 800 x 800 mm  
 850 x 800 x 1200 mm



Standard Profile



Supported Profile



Optional Wheels



DISPLAY BASKET SIGMA

(h x d x l)

860 x 450 x 900 mm

860 x 600 x 1000 mm



DISPLAY BASKET MEGA

(h x d x l)

630 x 600 x 1000 mm

630 x 800 x 1200 mm



DISPLAY BASKET EXTRA

(h x d x l)

1400 x 600 x 800 mm

1400 x 800 x 800 mm



DISPLAY BASKET MICRON

(h x d x l)

800 x 530 x 530 mm

800 x 800 x 800 mm



DISPLAY BASKET ZETA

(h x d x l)

850 x 600 x 800 mm

850 x 800 x 1200 mm



Wheeled Foot

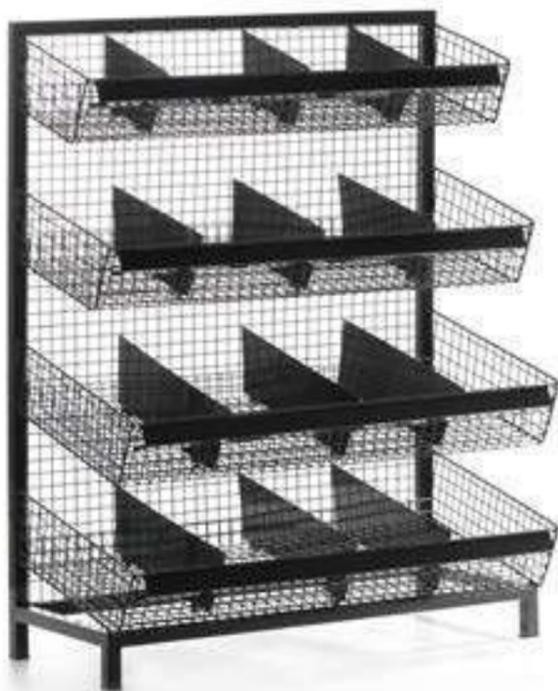

4 BASKETS DISPLAY UNIT

(h x d x l)  
1420 x 400 x 1200 mm



4 Basket Display Separator

(h x d)  
200 x 400 mm  
200 x 300 mm

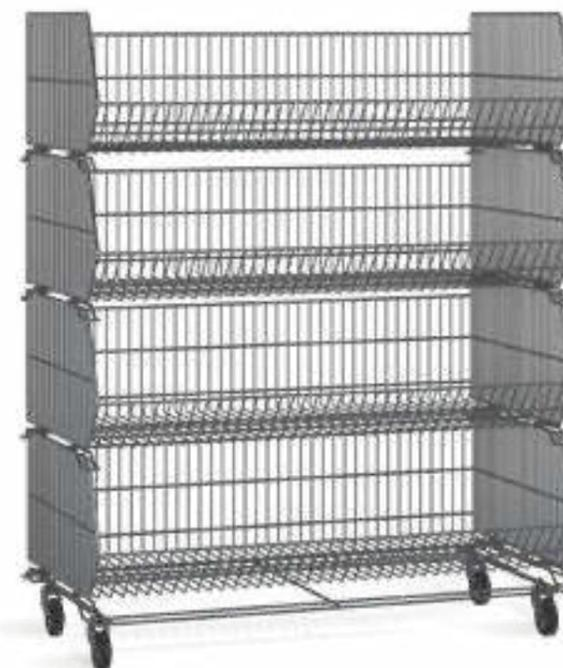

MULTI-TIER WIRE BASKET RACK

Rack Base

(h x d x l)  
97 x 497 x 1000 mm  
97 x 497 x 1250 mm

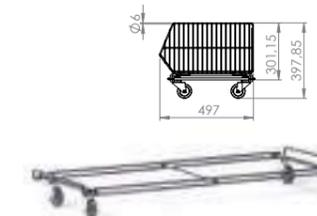

Wire Basket Rack

(h x d x l)  
264 x 497 x 1000 mm  
264 x 497 x 1250 mm

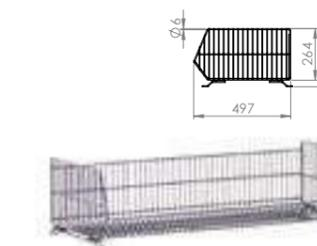

3 BASKETS DISPLAY UNIT

(h x d x l)  
1130 x 400 x 500 mm

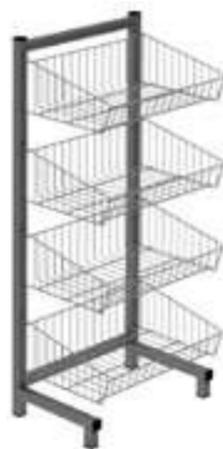

ONE SIDED ECO DISPLAY UNIT

(h x d x l)  
1210 x 635 x 500 mm  
1210 x 635 x 700 mm



DOUBLE SIDED ECO DISPLAY UNIT

(h x d x l)  
1210 x 1270 x 500 mm  
1210 x 1270 x 700 mm

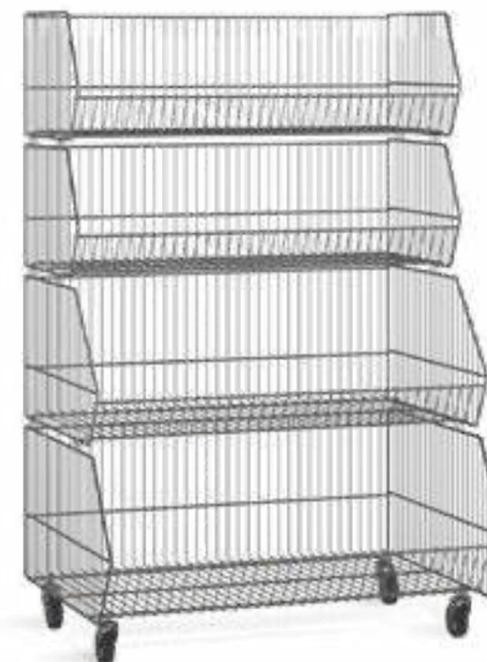

STEPPED WIRE BASKET RACK

Wire Wheeled Basket

(h x d x l)  
356 x 593 x 700 mm  
356 x 593 x 1000 mm

Stepped Wire Top Basket

(h x d x l)  
318 x 516 x 700 mm  
318 x 516 x 1000 mm  
275 x 404 x 700 mm  
275 x 404 x 1000 mm

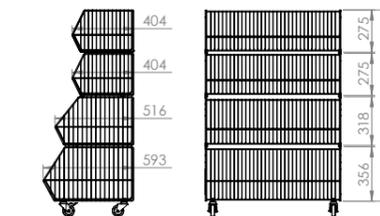

# DISPLAY ACCESSORIES



## ACCESSORIES FOR PERFORATED PANELS (DSG)

Accessories that are used on metal panels which are named as “perforated back panels” or “pegboards” in retail shelving systems. There are 3 models of this type of accessories which are all used on the same perforated panel.

- DSG** The most widely used standard model.
- DSG-K** These can be locked after fixing on the panel.
- DSG-P** Model with a metal pin, used in special/custom projects.



## ACCESSORIES FOR PROFILE BAR (ATG)

Accessories that are fitted on the profile bars (accessory holders) used in retail shelving systems.

**ATG** model is compatible with plain profile bars. It's a standard and common model. Plain profile bar depth (thickness) can be 15 mm or 20 mm.

**OTG** model is compatible with oval profile bars. It's not a widely preferred model and used in custom/special projects.



ATG type accessories' dimensions vary depending on the profile bar's. For 15×30 mm profile bar, the back of the accessory (fitting point) will be 15 mm, for 20×30 mm and 20×40 mm profile bars, the back of the accessory (fitting-point) will be 20 mm. Pay 15 mm attention when purchasing such accessories.

## ACCESSORIES FOR SLATWALL PANELS (KPG)

Accessories that are used on wooden slatwall panels. Except for some special cases, these panels are universal.



## ACCESSORIES FOR WIRE MESH PANELS (MG)

These accessories are compatible with widely used 50×50 mm grids of the wire mesh panels. They can also be configured for custom grid sizes.

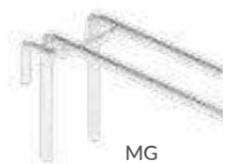

## ACCESSORIES FOR UPRIGHTS (DG)

Accessories that are fitted on the profile uprights of the retail shelving systems

The size of the fitting part of these accessories vary based on the pitch of the upright.

Models with a single fixing ledge are usually compatible with uprights of any pitch size.

These accessories are compatible with all slatwall panel models.



For accessories with more than one fixing ledge, the pitch size of the upright should be noted. The fixing ledges are manufactured according to that pitch size. (Our fixing ledges are manufactured for 25 mm and 35 mm pitch sizes.)

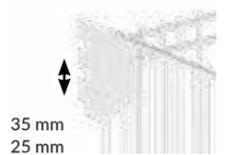



LOCKED WIRE HOOK DSG-K DOUBLE

(d x Ø)  
200 mm - Ø4  
300 mm - Ø5  
400 mm - Ø5



LOCKED WIRE HOOK DSG-K WITH LABEL HOLDER

(d x Ø)  
200 mm - Ø5  
300 mm - Ø6  
400 mm - Ø6



LOCKED WIRE HOOK DSG-K

(d x Ø)  
200 mm - Ø5  
300 mm - Ø6  
400 mm - Ø6



WIRE HOOK KPG

(d x Ø)  
150 mm - Ø5  
200 mm - Ø5  
250 mm - Ø6  
300 mm - Ø6  
400 mm - Ø6

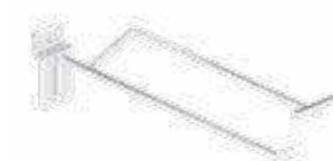

WIRE HOOK KPG WITH LABEL HOLDER

(d x Ø)  
150 mm - Ø5  
200 mm - Ø5  
250 mm - Ø6  
300 mm - Ø6  
400 mm - Ø6

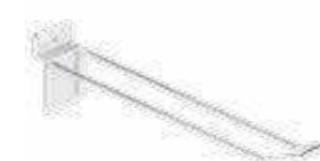

WIRE HOOK KPG DOUBLE

(d x Ø)  
150 mm - Ø4  
200 mm - Ø4  
250 mm - Ø5  
300 mm - Ø5  
400 mm - Ø5

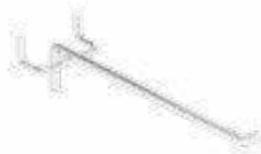

WIRE HOOK DSG

(d x Ø)  
150 mm - Ø5  
200 mm - Ø5  
250 mm - Ø6  
300 mm - Ø6

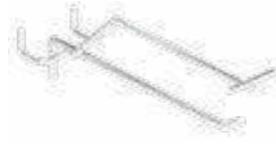

WIRE HOOK DSG WITH LABEL HOLDER

(d x Ø)  
150 mm - Ø5  
200 mm - Ø5  
250 mm - Ø6  
300 mm - Ø6



WIRE HOOK DSG DOUBLE

(d x Ø)  
150 mm - Ø4  
200 mm - Ø4  
250 mm - Ø5  
300 mm - Ø5  
400 mm - Ø5



WIRE HOOK DSG DOUBLE WITH LABEL

(d x Ø)  
150 mm - Ø4  
200 mm - Ø4  
250 mm - Ø5  
300 mm - Ø5  
400 mm - Ø5



WIRE HOOK KPG DOUBLE WITH LABEL

(d x Ø)  
150 mm - Ø4  
200 mm - Ø4  
250 mm - Ø5  
300 mm - Ø5  
400 mm - Ø5

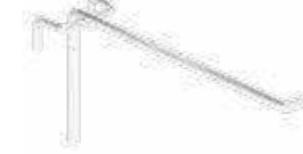

WIRE HOOK MG

(d x Ø)  
150 mm - Ø5  
200 mm - Ø5  
250 mm - Ø6  
300 mm - Ø6  
400 mm - Ø8

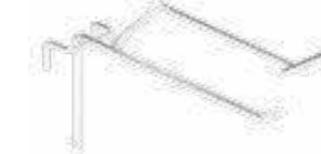

WIRE HOOK MG WITH LABEL HOLDER

(d x Ø)  
150 mm - Ø5  
200 mm - Ø5  
250 mm - Ø6  
300 mm - Ø6  
400 mm - Ø8



WIRE HOOK ATG

(d x Ø)  
150 mm - Ø5  
200 mm - Ø5  
250 mm - Ø6  
300 mm - Ø6  
400 mm - Ø8



WIRE HOOK ATG WITH LABEL HOLDER

(d x Ø)  
150 mm - Ø5  
200 mm - Ø5  
250 mm - Ø6  
300 mm - Ø6  
400 mm - Ø8



WIRE HOOK ATG DOUBLE

(d x Ø)  
150 mm - Ø4  
200 mm - Ø4  
250 mm - Ø5  
300 mm - Ø5  
400 mm - Ø5



WIRE HOOK ATG DOUBLE WITH LABEL HOLDER

(d x Ø)  
150 mm - Ø4  
200 mm - Ø4  
250 mm - Ø5  
300 mm - Ø5  
400 mm - Ø5

WIRE HOOK MG DOUBLE

(d x Ø)  
150 mm - Ø4  
200 mm - Ø4  
250 mm - Ø5  
300 mm - Ø5  
400 mm - Ø5



WIRE HOOK MG DOUBLE WITH LABEL HOLDER

(d x Ø)  
150 mm - Ø4  
200 mm - Ø4  
250 mm - Ø5  
300 mm - Ø5  
400 mm - Ø5

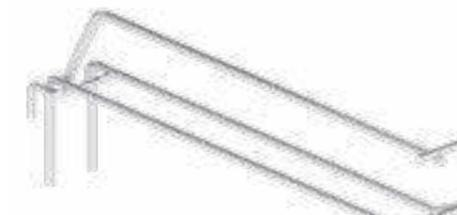

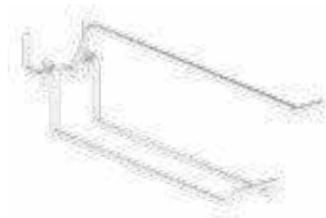

GRINDER HOLDER WIRE HOOK DSG

(h x d)

85 x 200 mm

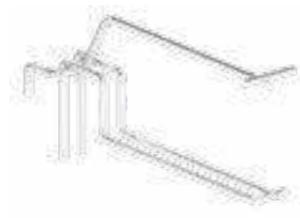

GRINDER HOLDER WIRE HOOK MG

(h x d)

85 x 200 mm



HIGH LABEL WIRE HOOK ATG

(h x d)

60 x 100 mm - Ø5  
60 x 150 mm - Ø5

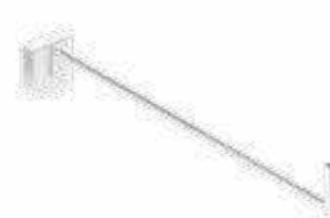

DUVET HOLDER ATG

(d x Ø)

350 mm - Ø10  
550 mm - Ø10



QUILT HOLDER ATG

(d x Ø)

550 mm - Ø10



LAMP SHADE HOLDER ATG

(h x d)

40 x 300 mm - Ø10



SHOVEL HOLDER SET ATG

(d)

535 mm - Ø10



SLEDGE HOLDER ATG & DSG

(h x d x l)

70 x 240 x 38 mm



HAMMER HOLDER ATG & DSG

(h x d x l)

50 x 310 x 30 mm

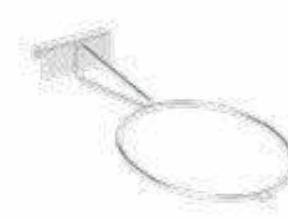

POT HOLDER ATG

(d x l)

330 x 200 mm



POT HOLDER KPG

(d x l)

300 x 180 mm



SLEEPING BAG HOLDER TYPE 1

(h x d x l)

300 x 80 x 560 mm



TROWEL HOLDER DSG

(d x l)

300 x 70 mm



TROWEL HOLDER ATG

(d x l)

300 x 70 mm

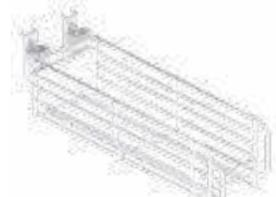

ROLL HOLDER DSG-P & ATG

(h x d x l)

105 x 357 x 124 mm



\*2 pieces required

MIRROR HOLDER KPG

(d x l)

15 x 50 mm



\*2 pieces required

AIR CONDITIONER HOLDER ATG

(d x l)

50 x 25 mm

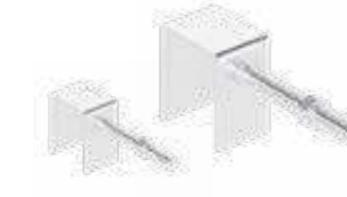

\*2 pieces required

HEATING BOILER HOLDER ATG

(d x l)

50 x 25 mm





\*Double used.

PRODUCT PRESENTER KPG

(d x l)  
50 x 40 mm

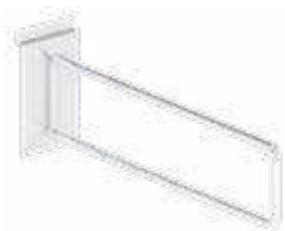

PRODUCT SEPARATOR KPG

(h x d)  
100 x 400 mm



PRODUCT SEPARATOR ATG

(h x d)  
100 x 400 mm



PRODUCT SEPARATOR PROFILE ATG

(d)  
400 mm  
500 mm  
600 mm  
25x25 profile



PRODUCT SEPARATOR PROFILE TRV

(d)  
400 mm  
500 mm  
600 mm  
700 mm  
25x25 profile  
For 40 mm beam.



PRODUCT SEPARATOR TUBE ATG

(d)  
400 mm  
500 mm  
600 mm  
Ø21 profile



PRODUCT SEPARATOR TUBE TRV

(d)  
400 mm  
500 mm  
600 mm  
700 mm  
Ø21 profile  
For 40 mm beam.



PRODUCT SEPARATOR ATG

(h x d)  
(500 / 1000) x 400 mm  
(500 / 1000) x 500 mm  
(500 / 1000) x 600 mm

Ø10 wire  
The product requires x2 accessory bars.



TOILET SEAT COVER HOLDER ATG

(h x d x l)  
85 x 40 x 180 mm



TOILET SEAT COVER HOLDER TRV

(h x d x l)  
85 x 40 x 180 mm



TOILET TANK KIT HOLDER ATG

(h x d x l)  
305 x 122 x 250 mm



SINGLE VERTICAL FAUCET HOLDER ATG TYPE 1

(h x d x l)  
78 x 103 x 142 mm



Slot Diameter  
Ø30 mm  
Ø40 mm



SINGLE VERTICAL FAUCET HOLDER ATG TYPE 2

(h x d x l)  
120 x 100 x 114 mm



Slot Diameter  
Ø30 mm  
Ø40 mm



DOUBLE HORIZONTAL FAUCET HOLDER ATG TYPE 2

(h x d x l)  
120 x 100 x 229 mm



Slot Diameter  
Ø30 mm  
Ø40 mm



COUNTER TOP BATTERY STAND

(h x d x l)  
498 x 220 x 285 mm



GRINDER STAND

(h x d x l)  
500 x 240 x 160 mm



STICK HOLDER DSG

(h x d x l)  
250 x 300 x 300 mm

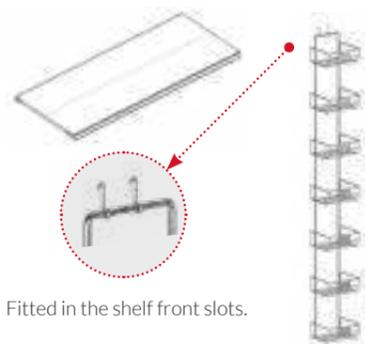

Fitted in the shelf front slots.

SHELF FRONT DISPLAY STAND

(h x d x l)

1310 x 140 x 150 mm

Basket Dimension

(h x d x l)

60 x 125 x 150 mm

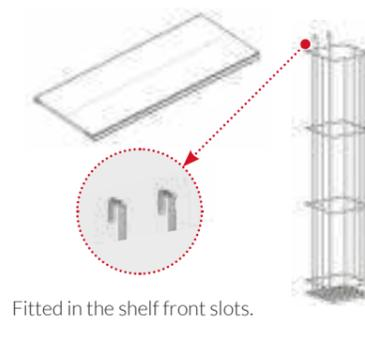
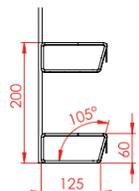

Fitted in the shelf front slots.

SHELF FRONT DISPLAY BASKET

(h x d x l)

1000 x 150 x 150 mm



HAIR DRYER HOLDER ATG

(h x d x l)

255 x 230 x 105 mm



HAIR DRYER HOLDER KPG

(h x d x l)

255 x 230 x 105 mm



CURLING IRON HOLDER ATG

(h x d x l)

230 x 330 x 60 mm



CURLING IRON HOLDER KPG

(h x d x l)

230 x 330 x 60 mm

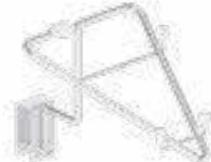

IRON HOLDER ATG

(h x d x l)

150 x 160 x 150 mm

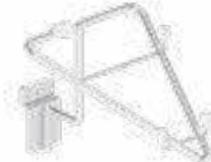

IRON HOLDER KPG

(h x d x l)

150 x 160 x 150 mm

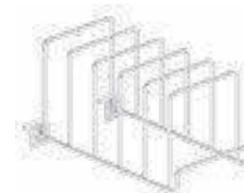

PLATE HOLDER ATG

(h x d x l)

200 x 400 x 300 mm



BALL HOLDER ATG

(d x l)

270 x 200 mm Round Diameter 200 mm



BALL HOLDER KPG

(d x l)

270 x 200 mm Round Diameter 200 mm



BALL HOLDER ATG

(h x d x l)

500 x 525 x 150 mm



BALL HOLDER OTG

(h x d x l)

500 x 525 x 150 mm



REINFORCED BALL HOLDER OTG

(h x d x l)

25 x 250 x 150 mm Round Diameter 150 mm



CURLING IRON HOLDER KPG

(h x d x l)

230 x 330 x 60 mm

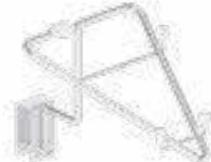

IRON HOLDER ATG

(h x d x l)

150 x 160 x 150 mm

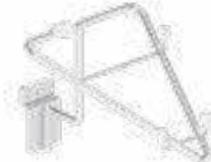

IRON HOLDER KPG

(h x d x l)

150 x 160 x 150 mm



SKATE HOLDER ATG

(h x d x l)

85 x 440 x 205 mm



SKATE HOLDER OTG

(h x d x l)

85 x 440 x 205 mm



\*Double used.

SKATEBOARD HOLDER ATG

(h x d x l)

330 x 400 x 120 mm





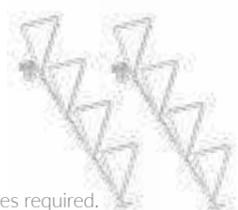

\*2 pieces required.

SKATEBOARD HOLDER OTG

(h x d x l)

330 x 400 x 120 mm



PRODUCT HOLDER WIRE HOOK OTG

(d)

250 mm - Ø6  
300 mm - Ø6  
400 mm - Ø6



SLEEPING BAG HOLDER TYPE 2

(h x l)

457 x 557 mm



SLOPING HANGER OVAL ATG

(d)

300 mm - 6 pins  
400 mm - 8 pins

15x30 oval profile.



SLOPING HANGER OVAL KPG

(d)

300 mm - 6 pins  
400 mm - 8 pins

15x30 oval profile.



SLOPING HANGER TUBE ATG

(d)

300 mm - 6 pins  
400 mm - 8 pins

Ø25 tube.



STRAIGHT HANGER OVAL ATG

(d)

300 mm - Single pin  
400 mm - Single pin

15x30 oval profile.



STRAIGHT HANGER OVAL KPG

(d)

300 mm - Single pin  
400 mm - Single pin

15x30 oval profile.



STRAIGHT HANGER TUBE ATG

(d)

300 mm - Single pin  
400 mm - Single pin

Ø25 tube.



SLOPING HANGER TUBE KPG

(d)

300 mm - 6 pins  
400 mm - 8 pins

Ø25 tube.



OVAL STEPPED HANGER ATG

(d)

300 mm - 150 + 150  
400 mm - 200 + 200

15x30 oval profile.



OVAL STEPPED HANGER KPG

(d)

300 mm - 150 + 150  
400 mm - 200 + 200

15x30 oval profile.



STRAIGHT HANGER TUBE KPG

(d)

300 mm - Single pin  
400 mm - Single pin

Ø25 tube.



OVAL STRAIGHT HANGER ATG  
(WITH TOP STAINLESS WIRE)

(d)

300 mm - Single pin  
400 mm - Single pin

A wire support is used to protect the coating from hanging traces.

15x30 oval profile.



TUBE STRAIGHT HANGER ATG  
(WITH TOP STAINLESS WIRE)

(d)

300 mm - Single pin  
400 mm - Single pin

A wire support is used to protect the coating from hanging traces.

Ø25 tube.



TUBE STEPPED HANGER ATG

(d)

300 mm - 150+150  
400 mm - 200+200

Ø25 tube.



TUBE STEPPED HANGER KPG

(d)

300 mm - 150+150  
400 mm - 200+200

Ø25 tube.



OVAL STRAIGHT HANGER  
STAINLESS WIRE OTG

(d)

300 mm  
400 mm

A wire support is used to protect the coating from hanging traces.

15x30 oval profile.



OVAL STEPPED HANGER  
STAINLESS WIRE OTG

(d)

300 mm - 150+150  
400 mm - 200+200

A wire support is used to protect the coating from hanging traces.

15x30 oval profile.



OVAL U HANGER BAR DG

(d x l)

(300 / 400) x 600 mm  
(300 / 400) x 700 mm  
(300 / 400) x 900 mm  
(300 / 400) x 1000 mm  
(300 / 400) x 1250 mm

15x30 oval profile.



OVAL U HANGER BAR KPG

(d x l)

(300 / 400) x 600 mm  
(300 / 400) x 700 mm  
(300 / 400) x 900 mm  
(300 / 400) x 1000 mm

15x30 oval profile.

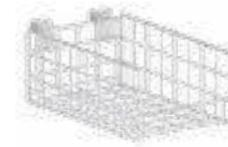

BASKET RACK MINI ATG

(h x d x l)

150 x 400 x 200 mm



BASKET RACK MINI OTG

(h x d x l)

150 x 400 x 200 mm

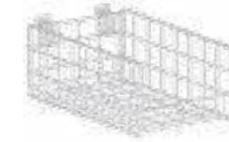

BASKET RACK MINI KPG

(h x d x l)

150 x 400 x 200 mm

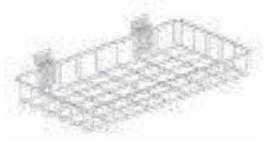

BASKET RACK KPG

(h x d x l)

75 x 250 x 450 mm

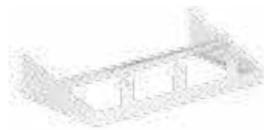

\*Specially designed for 25 & 35 pitch shelves.

REEL ROLL HOLDER RACK DG

(d x l)

370 x 700 mm (3 Gözlü)  
370 x 1000 mm (4 Gözlü)  
370 x 1250 mm (5 Gözlü)



\*Separator is not included.

SHELF TOP BASKET RACK

(h x d x l)

300 x (300 / 400 / 500 / 600) x 700 mm  
300 x (300 / 400 / 500 / 600) x 900 mm  
300 x (300 / 400 / 500 / 600) x 1250 mm  
300 x (300 / 400 / 500 / 600) x 1000 mm



\*Separator is not included.

\*Specially designed for 25 & 35 pitch shelves.

BASKET RACK DG

(h x d x l)

300 x (300 / 400 / 500 / 600) x 700 mm  
300 x (300 / 400 / 500 / 600) x 900 mm  
300 x (300 / 400 / 500 / 600) x 1250 mm  
300 x (300 / 400 / 500 / 600) x 1000 mm



SHELF TOP BASKET SEPARATOR

(h x d)

300 x (300 / 400 / 500 / 600) mm

BASKET RACK DG SEPARATOR

(h x d)

300 x (300 / 400 / 500 / 600) mm



\*Separator is not included.

BASKET RACK FIX ATG TYPE 1

(h x d x l)

300 x (300 / 400 / 500) x 640 mm  
300 x (300 / 400 / 500) x 880 mm

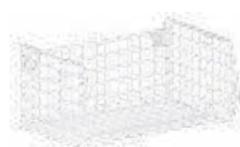

BASKET RACK SOV ATG

(h x d x l)

260 x 450 x 640 mm



BASKET RACK SOV OTG

(h x d x l)

260 x 450 x 640 mm

BASKET RACK FIX SEPARATOR

(h x d)

300 x (300 / 400 / 500) mm



ACCESSORY HOLDER BAR  
(20x30) SINGLE FIXING LEDGE

(h x d x l)

20 x 30 x 700 mm  
20 x 30 x 900 mm  
20 x 30 x 1000 mm  
20 x 30 x 1250 mm  
20 x 30 x 1330 mm



ACCESSORY HOLDER BAR  
(20x40) SINGLE FIXING LEDGE

(h x d x l)

20 x 40 x 700 mm  
20 x 40 x 900 mm  
20 x 40 x 1000 mm  
20 x 40 x 1250 mm  
20 x 40 x 1330 mm



ACCESSORY HOLDER BAR  
(15x30) SINGLE FIXING LEDGE

(h x d x l)

15 x 30 x 700 mm  
15 x 30 x 900 mm  
15 x 30 x 1000 mm  
15 x 30 x 1250 mm  
15 x 30 x 1330 mm



OVAL ACCESSORY HOLDER BAR  
(15x30) SINGLE FIXING LEDGE

(h x d x l)

15 x 30 x 700 mm  
15 x 30 x 900 mm  
15 x 30 x 1000 mm  
15 x 30 x 1250 mm  
15 x 30 x 1330 mm



Brackets included.

WIRE SHELF DG 25

(d x l)

(300 / 400 / 500) x 700 mm  
(300 / 400 / 500) x 900 mm  
(300 / 400 / 500) x 1000 mm  
(300 / 400 / 500) x 1250 mm



Brackets included.

WIRE SHELF DG 35

(d x l)

(300 / 400 / 500) x 550 mm  
(300 / 400 / 500) x 750 mm  
(300 / 400 / 500) x 950 mm  
(300 / 400 / 500) x 1250 mm



PLASTIC LABEL HOLDER  
FOR WIRE HOOK

(h x l)

39 x 45 mm  
39 x 60 mm  
39 x 90 mm



PLASTIC DOUBLE WIRE  
HOOK LABEL

(h x l)

36 x 20 mm



PLASTIC LABEL HOLDER  
FOR WIRE HOOK

(h x l)

36 x 20 mm



**HANDLING  
EQUIPMENT**

VENUS SHOPPING TROLLEY

The most popular model in the world with its solid chassis structure. It offers a solid and dynamic comfort with its oval profile chassis. With capacities ranging from 80 liters to 240 liters, a VENUS series shopping trolley is suitable for any store, in any size.

Plastic Color Options

- Standard Color RAL 3020
- Optional RAL 5015
- Optional RAL 6018
- Optional RAL 2004
- Optional RAL 1023

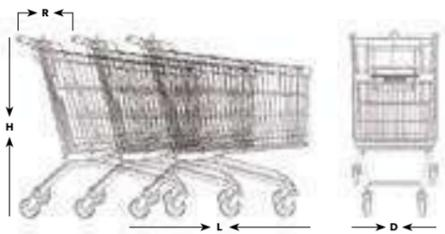

NEPTUN SHOPPING TROLLEY

Stylish and strong with its "all-wire" structure. You can use the upper basket more efficiently by moving the bottled or boxed products to the extra space at the bottom. Thus, you can have an increased turnover with this higher total capacity. Ranging from 80 to 240 liters, a NEPTUN series shopping trolley adds efficiency to every store.

Plastic Color Options

- Standard Color RAL 3020
- Optional RAL 5015
- Optional RAL 6018
- Optional RAL 2004
- Optional RAL 1023



Capacity	80 lt.	100 lt.	125 lt.	150 lt.	180 lt.	210 lt.	240 lt.
Max Load	75 kg.	90 kg	100 kg	130 kg	150 kg	160 kg	180 kg
Height (H)	950 mm	950 mm	1010 mm	1010 mm	1020 mm	1010 mm	1000 mm
Depth (D)	510 mm	510 mm	550 mm	570 mm	590 mm	570 mm	590 mm
Length (L)	850 mm	860 mm	900 mm	990 mm	1020 mm	1100 mm	1120 mm
Nesting Distance (R)	215 mm	215 mm	215 mm	240 mm	200 mm	250 mm	300 mm
40 HQ Container	600	600	500	550	570	436	364
Truck	580	580	448	496	496	400	400

Capacity	80 lt.	100 lt.	125 lt.	150 lt.	180 lt.	210 lt.	240 lt.
Max Load	75 kg.	90 kg	100 kg	130 kg	150 kg	160 kg	180 kg
Height (H)	960 mm	960 mm	960 mm	1000 mm	1040 mm	1050 mm	1060 mm
Depth (D)	510 mm	510 mm	550 mm	580 mm	585 mm	570 mm	590 mm
Length (L)	800 mm	860 mm	890 mm	1020 mm	1030 mm	1100 mm	1120 mm
Nesting Distance (R)	190 mm	190 mm	225 mm	245 mm	245 mm	245 mm	230 mm
40 HQ Container	650	630	550	440	440	440	460
Truck	580	580	448	496	496	400	400

Turnover hunter" of small stores! Offering a volume of 115 liters and thanks to its deep basket design, NOVA has the smallest size compared to its counterparts. Designed for narrow aisles, NOVA is an ideal choice for 300 to 800 square meter stores. NOVA, which is the choice of the biggest discount chains in the world, offers consumers a comfortable shopping experience.

NOVA SHOPPING TROLLEY

NOVA PC SHOPPING TROLLEY



Plastic Color Options

- Standard Color RAL 3020
- Optional RAL 5015
- Optional RAL 6018
- Optional RAL 2004
- Optional RAL 1023

LOOP PLASTIC SHOPPING TROLLEY

LOOP, the new generation plastic shopping trolley, offers maximum volume in minimum dimensions; thanks to its ergonomic chassis structure. LOOP is the ideal choice for narrow aisles.

With 3 different sizes, LOOP adds aesthetics and efficiency to your modern store concepts.



Plastic Color Options

- Basket Color RAL 7021
- Handle Color RAL 3020
- Handle Color Pantone 123C
- Handle Color Pantone 375C
- Handle Color Pantone 287C

Capacity	100 lt.	160 lt.	200 lt.
Max Load	100 kg.	150 kg.	190 kg.
Height (H)	1012 mm	1107 mm	1081 mm
Depth (D)	567 mm	597 mm	587 mm
Length (L)	587 mm	847 mm	1050 mm
Nesting (R)	125 mm	225 mm	215 mm
10 Trolleys Length	1712 mm	2782 mm	2985 mm



Capacity	120 lt.
Max Load	98 kg.
Height (H)	872 mm
Depth (D)	545 mm
Length (L)	987 mm
Nesting Distance (R)	165 mm
40 HQ Container Truck	650
	472



200 lt.



160 lt.



100 lt.

JUNIOR KIDS SHOPPING CAR

JR helps kids enjoy shopping while offering a large capacity with its 100 liters basket. The additional central caster provide a comfortable and safe environment for these little shoppers.

With its seat and steering wheel, JR gives kids the real-feel of a car and keeps them safe with built-in seat belt.

Basket Volume	100 lt.
Max Load	80 kg.
Height (H)	1030 mm
Width (D)	580 mm
Length (L)	1515 mm
40"HC Container (pcs)	65



EASY-B SHOPPING TROLLEY

Height (H)	1020 mm
Depth (D)	630 mm
Length (L)	1180 mm
Upper Basket	25 lt.
Hand Basket Volume	22 lt.
Seating Material	PE
Casters	100 mm TPE

Color Option

● Chassis RAL 7024

EASY-B TWIN SHOPPING TROLLEY

Height (H)	1020 mm
Depth (D)	630 mm
Length (L)	1060 mm
Hand Basket Volume	22 lt.
Seating Material	PE
Casters	100 mm TPE

Color Option

● Chassis RAL 7024

SWEET PLASTIC KIDS SHOPPING TROLLEY

SWEET is designed for the shopping pleasure of kids along with their parents. With its 20 liter capacity plastic baskets in two different colors, the cheerful-looking SWEET will make children love shopping.

Plastic Color Options

● Standard Color RAL 3020  
● Optional RAL 5015

Capacity	20 lt.
Height (H)	720 mm
Width (D)	375 mm
Height with Pole	1470 mm
Ads Area	50x130 mm
Flag	Optional





## M4 CARGO TROLLEYS

Mağazalar ve depolar içerisinde kutulu ürünleri hızlı bir şekilde transfer etmenin en iyi yolu M serisi arabaları kullanmaktır.

2 farklı ölçü seçeneği ile mağazalar içindeki koridorlarda rahatça manevra yapan M serisi ayrılabilen kol yapısı ile de kullanım dışındaki zamanlarda deponuzda daha az yer kaplar.

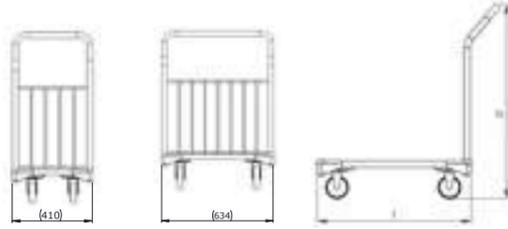

	MS	ML
Max Load	200 kg.	250 kg.
Height (H)	890 mm	1050 mm
Depth (D)	530 mm	650 mm
Length (L)	700 mm	950 mm



## D 70 CARGO TROLLEY

Hızlı, esnek ve çevik DIY-A, içi içe geçebilme özelliği ve ekstra arka sepeti ile rahat ve hacimli bir taşıma konforu sağlar. Dört adet hareketli tekerleği ile yüksek manevra kabiliyetine sahiptir. 200 Kg. yük taşıma kapasitesi ile her alanda kullanıcıya yardımcı olur.

Max Load	200 kg.
Height (H)	950 mm
Depth (D)	540 mm
Length (L)	870 mm
Nesting Distance (R)	20 lt.
Basket Volume	285 mm

## K4 CARGO TROLLEYS

## Color Options

- Chasis RAL 5010
- Chasis RAL 7046
- Chasis ZINC

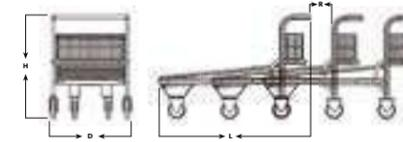

	K4-S	K4-L
Max Load	300 kg.	450 kg.
Height (H)	950 mm	950 mm
Depth (D)	610 mm	720 mm
Length (L)	1160 mm	1400 mm
Nesting Distance (R)	265 mm	265 mm



## K5 CARGO TROLLEY

## Color Options

- Chasis RAL 5010
- Chasis RAL 7046
- Chasis ZINC

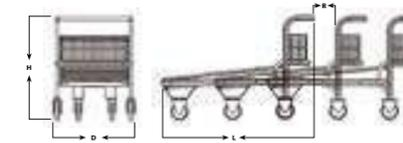

Max Load	450 kg.
Height (H)	950 mm
Depth (D)	720 mm
Length (L)	1400 mm
Nesting Distance (R)	265 mm



## ACCESSORIES FOR K SERIES TROLLEYS



**Coin Lock:** Keep your trolleys in place with the optional coin lock installed on the handle of the trolley. This coin lock can be configured for all types of coins.



**Note Board:** Suitable to be used for either your customers' shopping list or warehouse supervisor's products pick list.

TRANSPORTER

(h x d x l)  
 1600 x 500 x 900 mm  
 1600 x 600 x 1000 mm

TRANSPORTER NOTE



TRANSPORTER LADDER



2 SIDED ROLL CONTAINER

(h x d x l)  
 1800 x 710 x 810 mm



3 SIDED ROLL CONTAINER

(h x d x l)  
 1800 x 710 x 810 mm

ROLL SHELF

(d x l)  
 710 x 810 mm



4 SIDED SINGLE DOOR ROLL CONTAINER

(h x d x l)  
 1800 x 710 x 810 mm

TOP COVER MESH

(d x l)  
 710 x 810 mm

HANGER TUBE

(l)  
 710 mm



4 SIDED DOUBLE DOOR ROLL CONTAINER

(h x d x l)  
 1800 x 710 x 810 mm



4 SIDED ROLL CONTAINER

(h x d x l)  
 1800 x 710 x 810 mm



2 SIDED Z FRAME ROLL CONTAINER

(h x d x l)  
 1800 x 710 x 810 mm



The base can fold up to the side to allow nesting.





PLASTIC HAND BASKET 22 LT.

(h x d x l)  
225 x 300 x 425 mm



PLASTIC HAND BASKET 28 LT.

(h x d x l)  
250 x 335 x 490 mm



RAINY WHEELED BASKET 70 LT.

(h x d x l)  
450 x 400 x 570 mm  
Ön yükseklik : 400 mm



SHOPROLL WHEELED BASKET 65 LT.

(h x d x l)  
875 x 540 x 390 mm  
Ön yükseklik : 435 mm  
Sap Yüksekliği : 300 mm



PLASTIC HAND BASKET 26 LT.

(h x d x l)  
250 x 335 x 490 mm



WINDY WHEELED BASKET 54 LT.

(h x d x l)  
425 x 350 x 500 mm



BASKET HOLDER

(h x d x l)  
255 x 350 x 500 mm



MOBILE BASKET HOLDER

(h x d x l)  
255 x 350 x 500 mm

MECHANICAL GATE

(h x l)

1070 x 700 / 900 mm



LEAF TURNSTILE

(h x l)

1070 x 700 / 900 mm

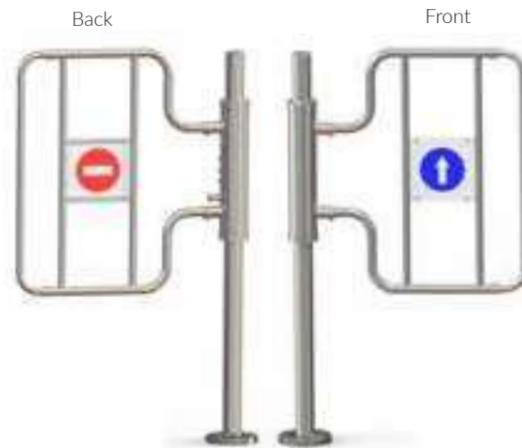

\* Anti-panic system with reverse opening gate on emergency.  
\*\* 700 - 900 mm adjustable gate.

ROTARY TURNSTILE

(h x d x l)

1070 x 1200 x 1500 mm



Fully openable door system for goods entry.  
Anti-panic system with reverse opening gate on emergency.



WALL STRIP BARRIER

(h)

250 mm

Strip Length: 2000 / 2500 mm

STRIP BARRIER

(h)

750 mm



GUIDANCE POST 2 SOCKETS

(h x l)

1070 x 190 mm

For Ø40 tube  
Order as Left or Right



GUIDANCE POST 2-WAY

(h x l)

1070 x 190 mm

For Ø40 tube



GUIDANCE POST CORNER

(h x l)

1070 x 190 mm



POST CONNECTING TUBE

(l)

1000 mm  
1250 mm



FLOOR BUMPER

(h x l)

175 x 77 mm

For Ø40 tube  
Order as Left or Right



FLOOR BUMPER 2-WAY

(h x l)

175 x 77 mm

For Ø40 tube



FLOOR BUMPER TUBE

(l)

1000 mm  
1250 mm



PARKING BARRIER

(h x d x l)

175 x 92 x 190 mm

Ø51 boru için  
Order as Left or Right



PARKING BARRIER 2-WAY

(h x d x l)

175 x 92 x 190 mm

For Ø51 tube



PARKING BARRIER CORNER

(h x d x l)

175 x 92 x 190 mm

For Ø51 tube  
Order as Left or Right



PARKING BARRIER 3-WAY

(h x d x l)

175 x 92 x 190 mm

For Ø51 tube



PARKING BARRIER TUBE

(l)

1000 mm  
1250 mm







**SOVA**  
RETAIL SOLUTIONS